

Zirkonzahn®

IMPLANT PROSTHETICS

All Components From A Single Source



WE ASSUME THE RESPONSIBILITY

UP TO 30 YEARS WARRANTY ON IMPLANT ABUTMENTS AND IMPLANTS

For the manufacture of our implant-supported components, we use high-quality titanium Grade 5 (ASTM F136, DIN EN ISO 5832-2). As one of the world's largest manufacturers, we meet the strictest quality criteria (ISO 13485 CMDCAS). We assume the responsibility for our products and grant therefore, in addition to the legally prescribed warranty obligation, voluntarily up to 30 years warranty on all Zirkozahn implant abutments used (titanium bases, Multi Unit Abutments, Multi Unit Abutments Angled, Raw-Abutments® as well as the corresponding screws). Within the current Zirkozahn warranty regulation, we explicitly include in our warranty also implants from other manufacturers used with Zirkozahn implant abutments.



The Zirkozahn warranty regulation can be viewed at www.zirkozahn.com.

EVERYTHING FROM A SINGLE SOURCE

Especially when manufacturing implant restorations it is important to optimally adjust components to one another. From the implant planning software to analogues for capturing already placed implants, titanium bases, Multi Unit Abutments and blanks with a pre-milled implant connection, we produce and develop everything on our own. All components are available for all common implant systems and are fully integrated in our Zirkonzahn Software. With the Zirkonzahn Library Download Center also 3shape and exocad® users can implement the libraries into their design software.

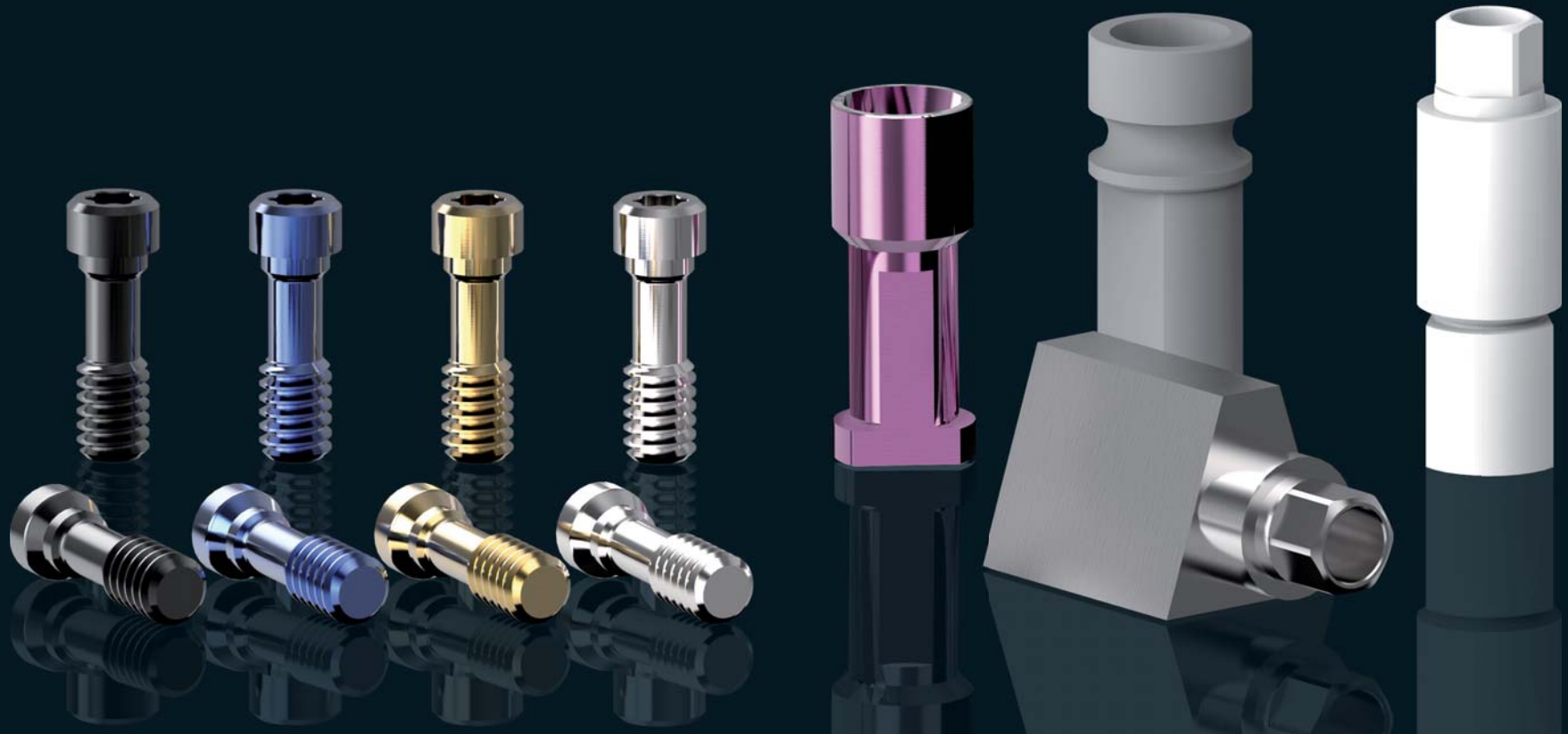



CAPTURE	TITANIUM BASES	RAW-ABUTMENTS®
---------	----------------	----------------

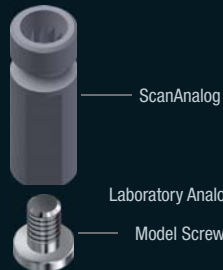
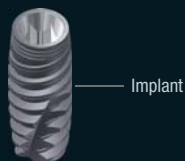
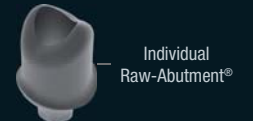
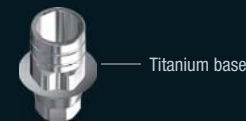
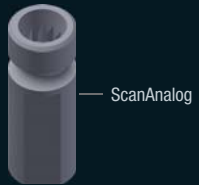
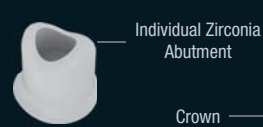
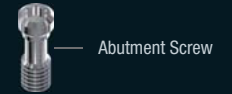
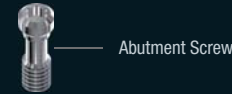
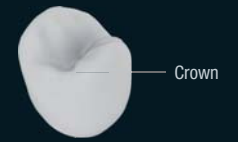
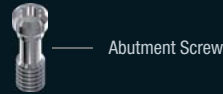
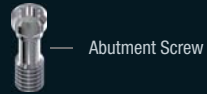
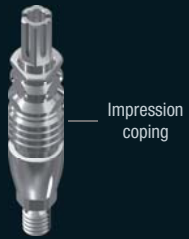

LOC-CONNECTOR

MULTI UNIT ABUTMENTS

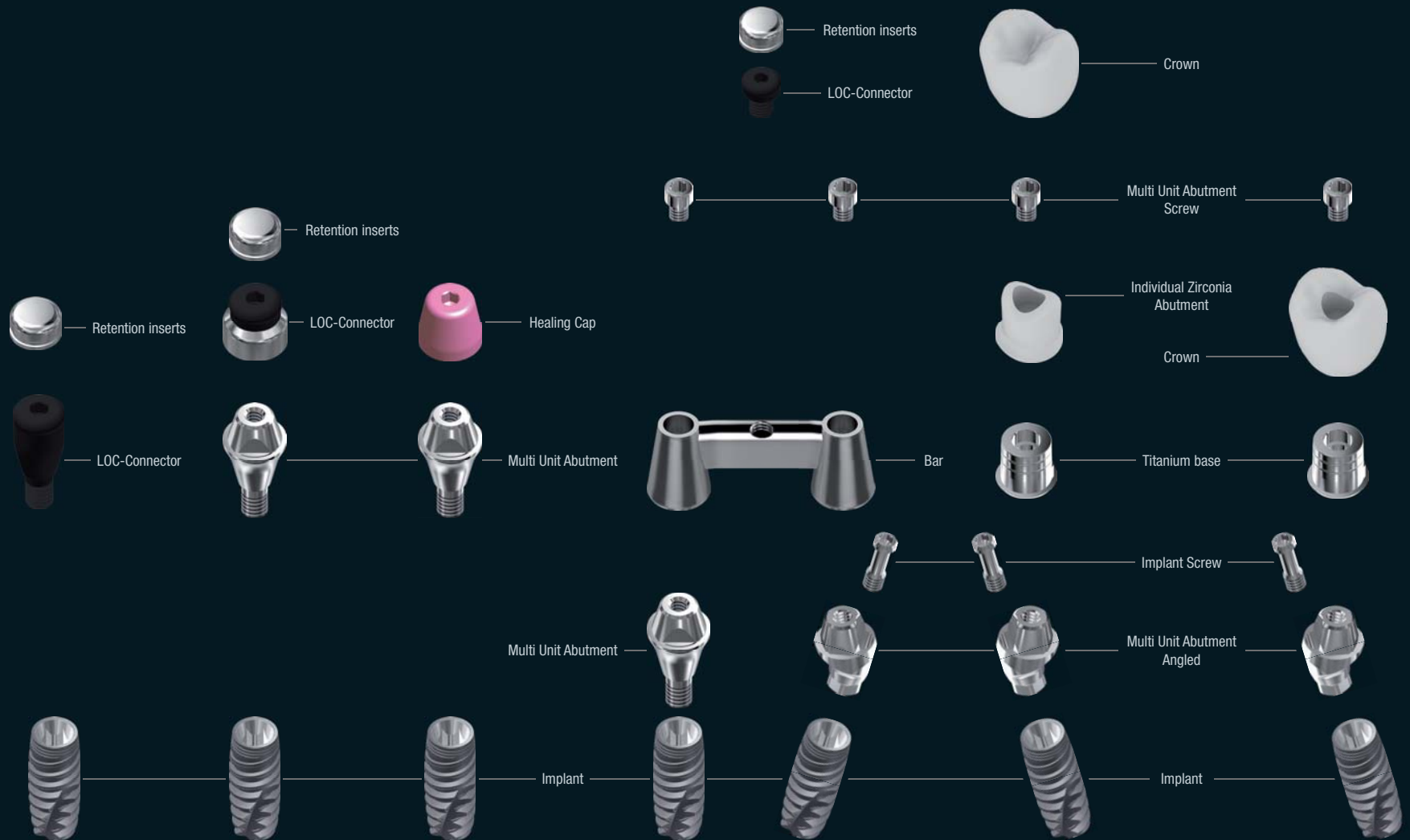

CAPTURE

TITANIUM BASES

RAW-ABUTMENTS®

MUA

LOC-CONNECTOR

TITANIUM POSTS

ACCESSORIES

OVERVIEW

SOFTWARE

ABUTMENTS FOR ALL COMMON IMPLANT SYSTEMS

Zirkonzahn Multi Unit Abutments (ZZ MUA)	Alpha-Bio Tec® SPI/DFI/ATID	Anthogyr® Axiom®	ASTRA TECH Implant System EV/UniAbutment® EV	ASTRA TECH Implant System OsseoSpeed™	ASTRA TECH UniAbutment®	A-Z Implant® MC	A-Z Implant® VL
BEGO Semados® Mini	BEGO Semados® S/RI/SC/SCX/RS/RSX-Line / MultiPlus System	BioHorizons® External	BioHorizons® Internal	BioHorizons® Multi-unit Abutment	Biomet 3i™ Certain® Implant System	Biomet 3i™ External Connection Implant System (OSSEOTITE®)	Biomet 3i™ Low Profile Abutment
Biotech Dental KONTACT	BrainBase Corporation MYTIS Arrow Implant	Bredent SKY® Classic / blueSKY	Bredent SKY® fast & fixed	Bredent SKY® uni.cone	BTI® Conical Spacer	BTI® Externa®	BTI® Interna®
BTI® Multi-Im®	BTI® Multi-Im® Angled®	BTI® Tiny®	Btk the smile system® – BT-Klassic	Btk the smile system® – BT-Konic	Btk the smile system® – BT-Isykone	Btk the smile system® – BT-Safe	CAMLOG® Bar Abutments (COMFOUR®)
CAMLOG® CERALOG® Hexalobe	CAMLOG® CONELOG®	CAMLOG® J-Line/K-Line	CAMLOG® VARIO SR	Champions® Implants (R)Evolution	Conmet® Hex	Connect®	Cowellmedi INNO Internal Implant System™
Cumdente	Dentalpoint AG ZerameX® P6	Dentalpoint AG ZerameX® XT	Dental Ration® OKTAGON® Bone Level	Dental Ration® OKTAGON® Multi Units Abutment	Dental Ration® OKTAGON® Tissue Level	DentalTech ImpLassic®	DentalTech ImpLassic®/Implogic®
Dentium Implantium / SuperLine	Dentium Screw Abutment	Dentsply Sirona® Ankylos® (Friadent) / Balance Base Abutment Narrow	Dentsply Sirona® XiVE® MP/TG	Dentsply Sirona® XiVE®/Frialit	Dyna Dental® Octalock/Helix	FairImplant FairTwo™	GC Tech. Aadva™

Implant Direct™ Legacy™	Implant Direct™ Overdenture Abutment	Intra-Lock® International FlatOne®	Intra-Lock® International Internal Implants	Intra-Lock® International Unihex™	K3Pro® Mini Konus/Standard	Klockner® Essential® Cone	Klockner® NK2/SK2
MEDENTIKA® MedentiBASE®	MEDENTIKA® M-Implant	Medentis medical ICX®-templant	Medentis medical ICX- multi®-Konzept	Megagen AnyOne®	Megagen AnyRidge®	Megagen ExFeel® External	Megagen ExFeel® Internal
MIS® C1	MIS® Multi Unit Abutment	MIS® Multi Unit System	MIS® SEVEN	MIS® V3	Moza-Grau® Tapered Screw®	Neo Biotech IS	Neoss® ProActive®
Nobel Biocare® Bränemark System® MkII/Shorty/ Groovy® / NobelSpeedy Shorty/Groovy®	Nobel Biocare® Multi-unit Abutment	Nobel Biocare® NobelActive®/ NobelReplace® CC/ Nobel Parallel CC	Nobel Biocare® NobelReplace®/ Replace Select Tapered/NobelSpeedy®	Nobel Biocare® NobelZygoma	OSSTEM Implant Convertible Abutment	OSSTEM Implant GS/TS	OSSTEM Implant GS/TS Multi Abutment
OSSTEM Implant US	Paltop® Conical Active	Paltop® Internal HEX Connection	PHIBO® TSA® Advance	SIC® invent SICace®	SGS Dental Conical Platform	Southern Implants® Deep Conical	Southern Implants® External Hex
Southern Implants® Internal Hex	Southern Implants® IT Connection	Straumann® Bone Level®	Straumann® Multibase Abutment	Straumann® Screw-Retained Abutment	Straumann® Tissue Level (Standard Plus Narrow Neck CrossFit® / SynOcta®)	Sweden & Martina Outlink2	Sweden & Martina P.A.D® Multi Unit Abutment
Sweden & Martina Prama	Sweden & Martina Premium Kohno®	Tekka® In-Kone®	Thommen Medical SPI®	Thommen Medical SPI® VARIOmulti	Warantec Oneplant	Zimmer Dental® Tapered Screw-Vent®	Zimmer Dental® Tapered Screw-Vent® Multi Unit Abutment

...

The system's library is expanded continually. An overview of all systems stored in the software and information regarding the torques are available at www.zirkonzahn.com/implant-systems or by telephone (+39 0474 066 680).

LABORATORY ANALOGUES

The laboratory analogues made from ASTM-approved titanium grade 5 replicate the exact position and connection to the implant. This enables to check the fitting accuracy of the final restoration with implant abutments directly on the model. To distinguish the different diameters, the analogues are also available pre-coloured.

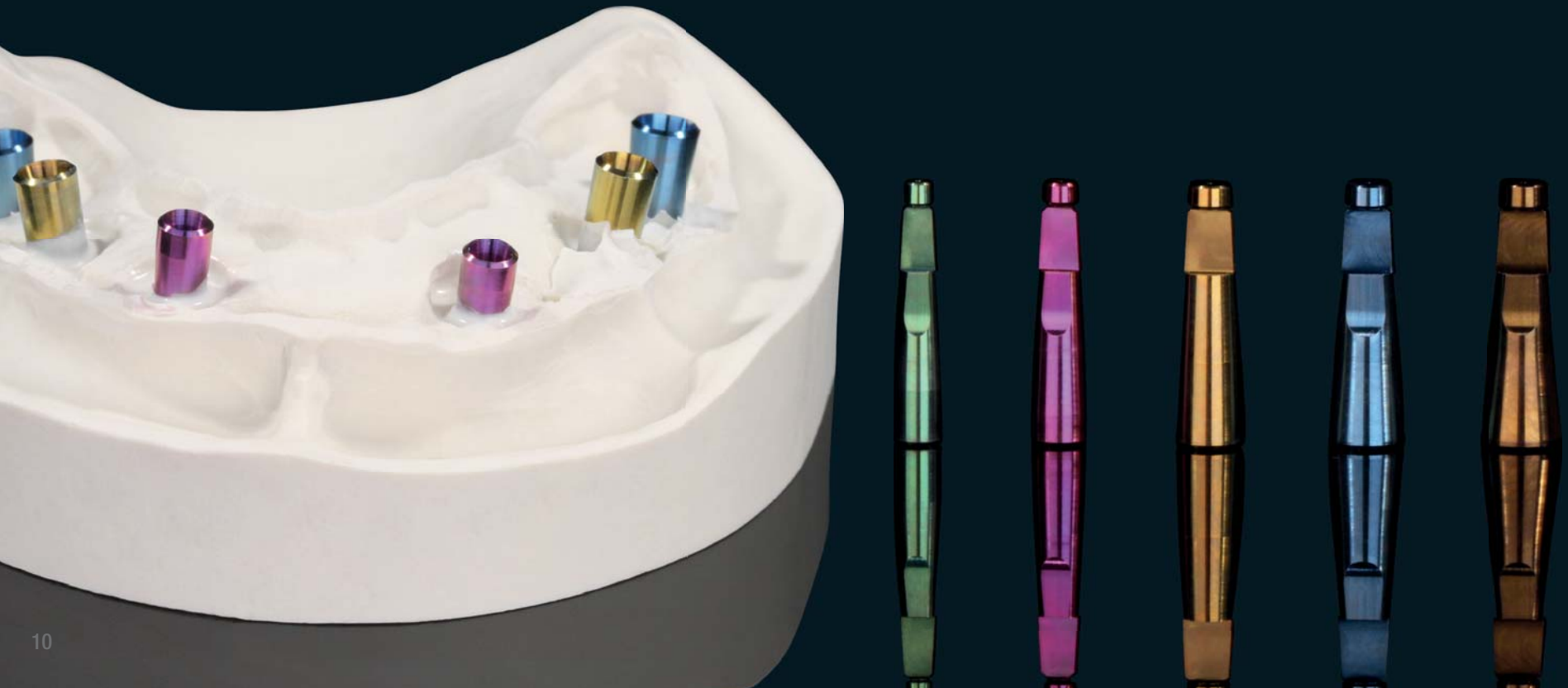

HEALING CAPS

Healing caps are used during the healing phase to seal the implant and to define the emergence profile. They can be anodised in different colours or are available already anodised in golden or pink.

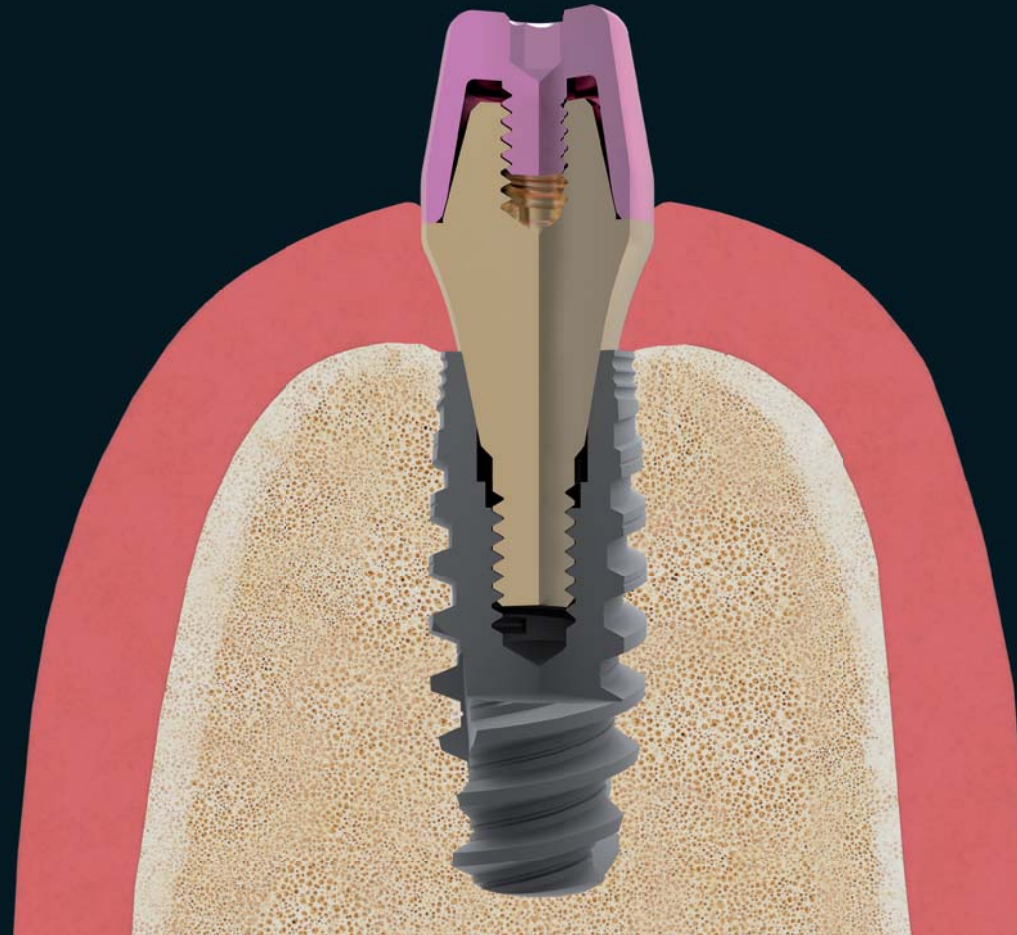

SCANANALOGS

ScanAnalogs unite the function of a laboratory analogue with the one of a scanmarker. In contrast to conventional scanmarkers, ScanAnalogs are screwed onto the traditional impression copings in the impression and digitised with Zirkonzahn's scanner for models. The captured implant position can be directly transferred into the software without a plaster model. Physical models can then be produced from the acquired data (CAD/CAM Model Maker software module). In their role as laboratory analogues, ScanAnalogs replicate the exact position and orientation of the implants on the model.

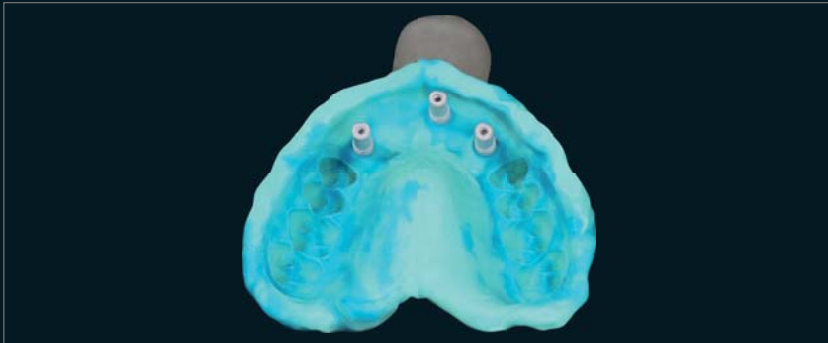

SCANMARKER

Thanks to the extremely precise geometry of Scanmarkers and with the aid of one of Zirkozahn's scanners, it is possible to transfer the exact position and orientation of the implants from the model into the software.

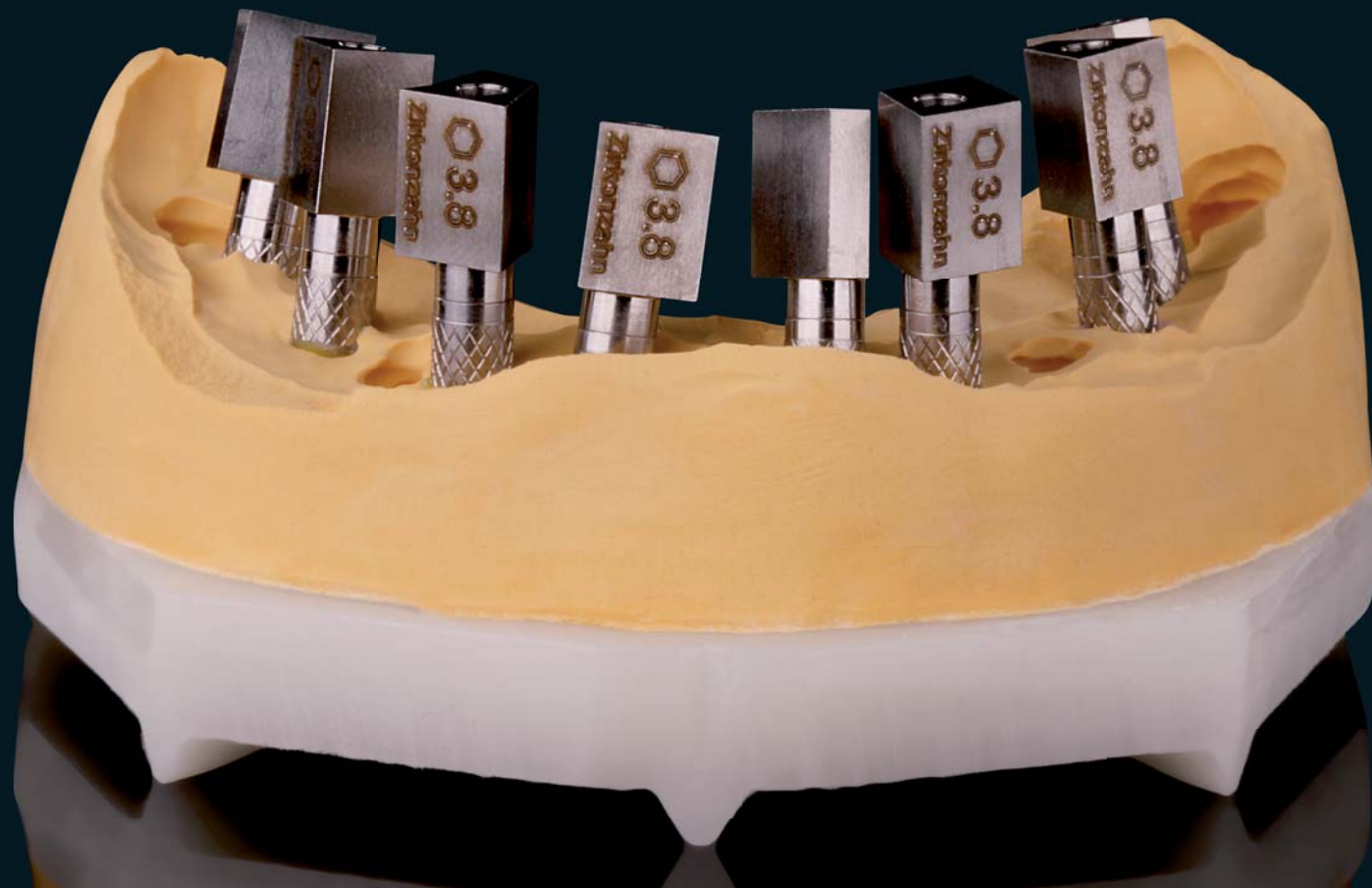

WHITE SCANMARKER

White Scanmarkers are used while scanning to capture the implants' position and orientation. Thanks to the white surface, which is not reflective, White Scanmarkers are especially suitable for application in the patient's mouth. Since the geometry of White Scanmarkers is held extremely small, scans are also possible with implants that are positioned very deeply or closely together. White Scanmarkers can also be used as Scanmarkers on the plaster model.



WHITE METAL SCANMARKER

White Metal Scanmarkers perform the same functions of White Scanmarkers, capturing the position and orientation of the implants during intraoral or model scanning. Unlike White Scanmakers, their metal surface and structure make them reusable, more accurate and dimensionally stable as well as more resistant. The plasma coating in a white colour prevents light reflection during scanning and the metallic body makes them appear opaque on x-rays.

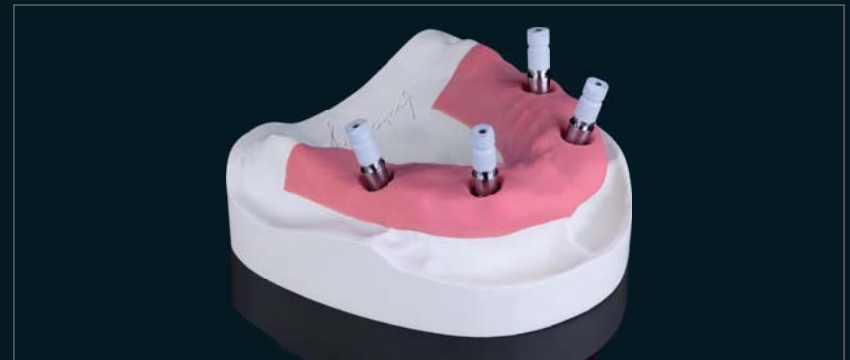
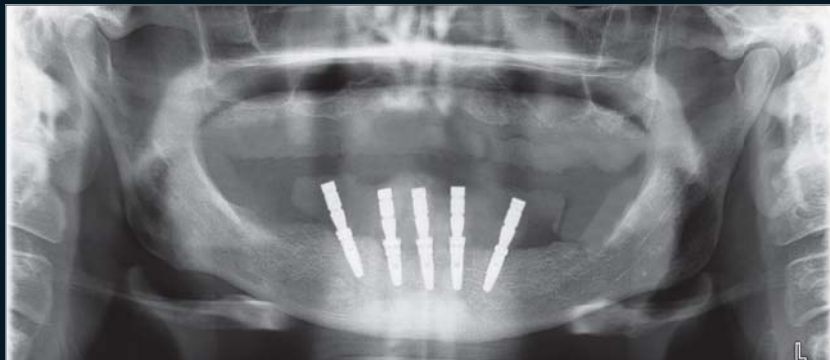

IMPRESSION COPING

Our stable impression copings are used in two ways: either in combination with laboratory analogues for the exact transfer of the implant positions in the jaw onto the plaster model or together with ScanAnalogs in the software.

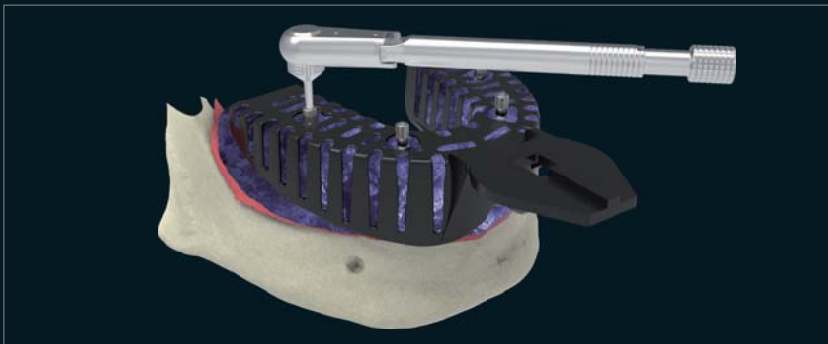
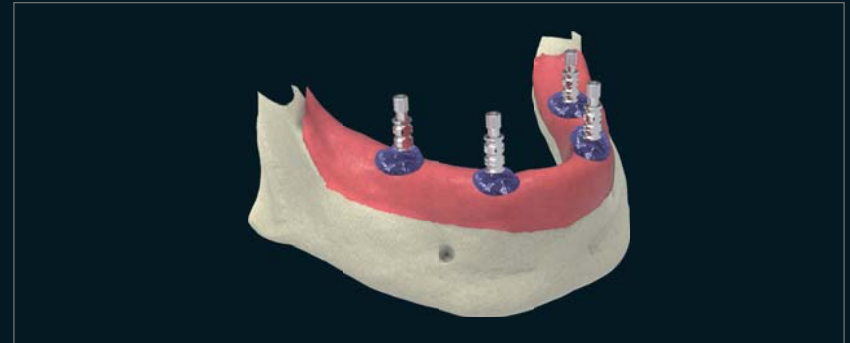
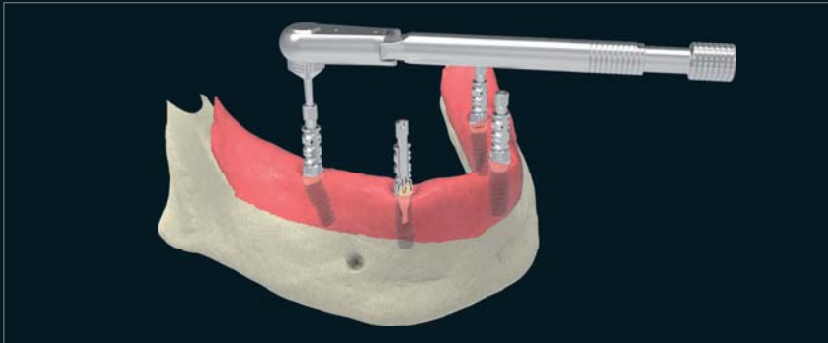

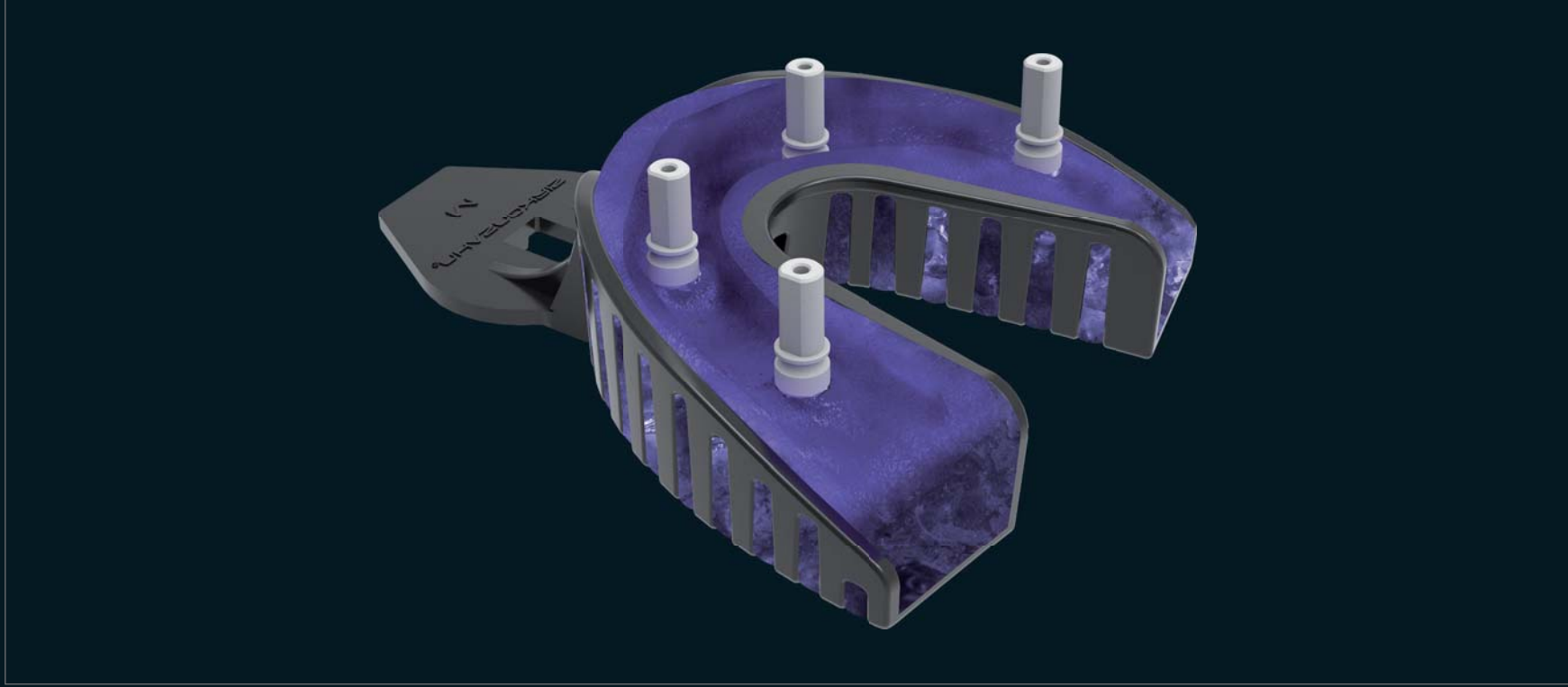

IMPRESSION TAKING WITH OPEN/CLOSED TRAYS AND IMPRESSION COPINGS

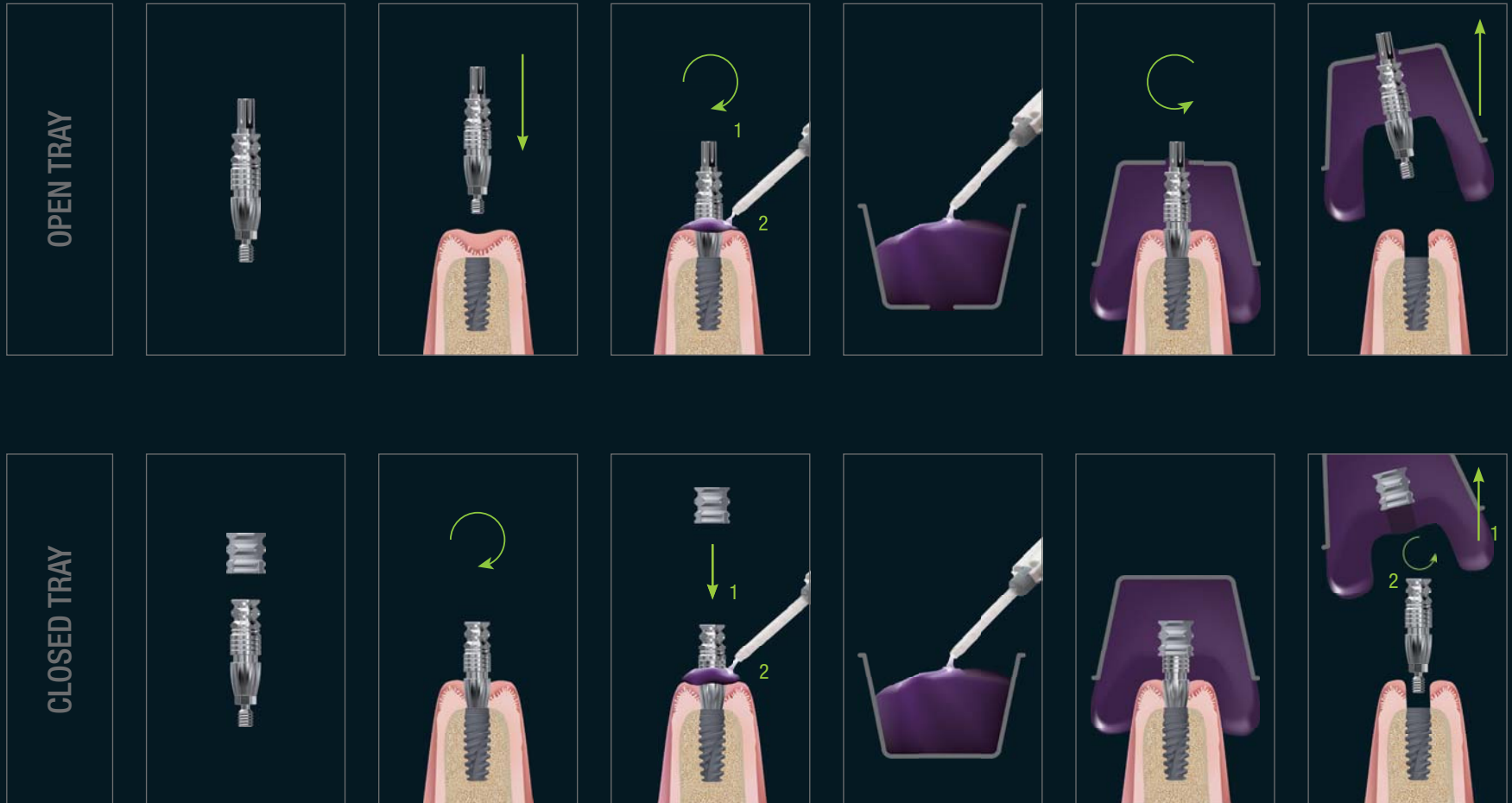

LABORATORY ANALOGUES

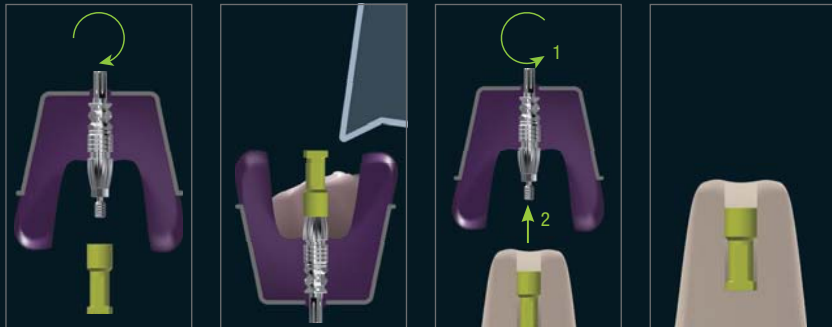

SCANANALOGS

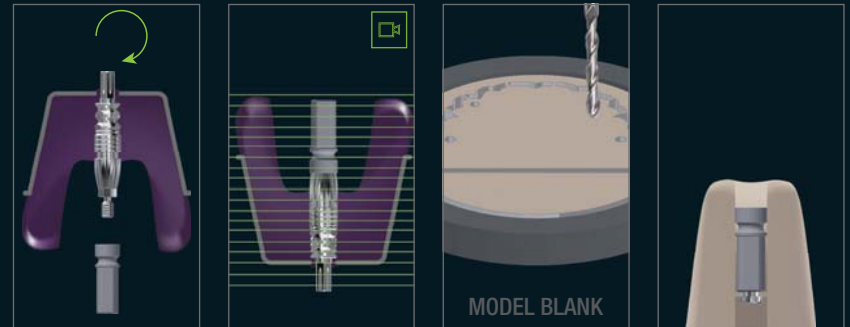

LABORATORY ANALOGUES

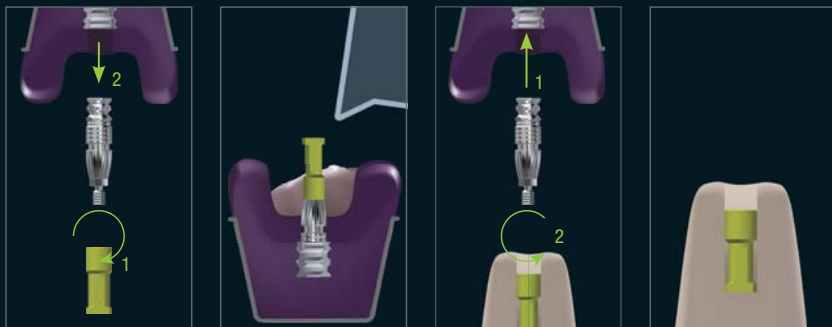

SCANANALOGS

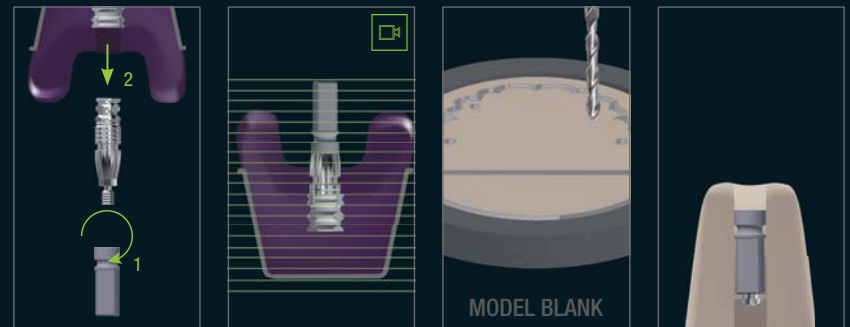

TITANIUM BASES

The use of titanium bases reduces the effect of transverse forces on the restoration, in contrast to restorations screwed directly on the implant. We generally recommend the use of titanium bases for all screw-retained implant structures, particularly though for those in the anterior tooth region.

TITANIUM BASES IN 5 HEIGHTS...

Except for Narrow Titanium bases, Zirkonzahn titanium bases are available in up to five different platform heights, in order to bring the implant to the desired gingival level. Due to their narrow geometry, Narrow Titanium Bases are particularly suitable for use in the anterior sector.

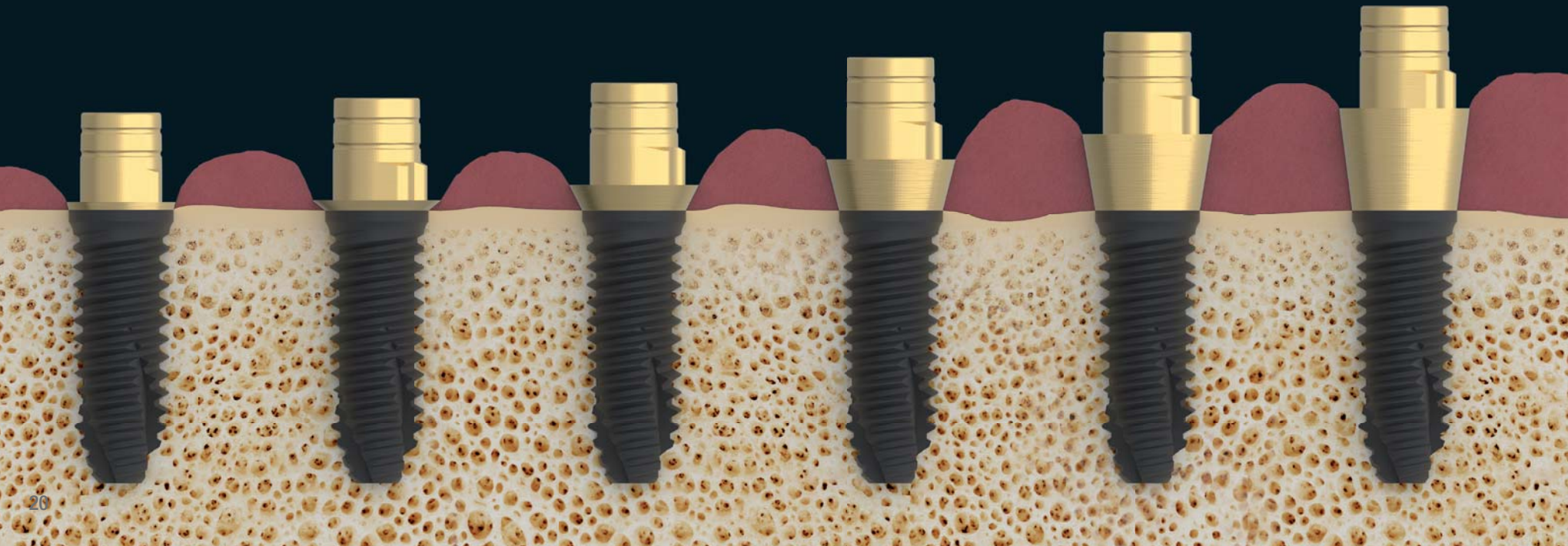

... GOLD-PLATED AND ANODISED

All Zirkonzahn titanium bases are available with a high quality gold plating. The gold coating increases the bio-compatibility and the golden shade reduces the grey value of the entire restoration.

Moreover, titanium bases can also be anodised in different colours using the Titanium Spectral-Colouring Anodizer or the Metal Colourizer. The high biocompatibility of the material remains unchanged.

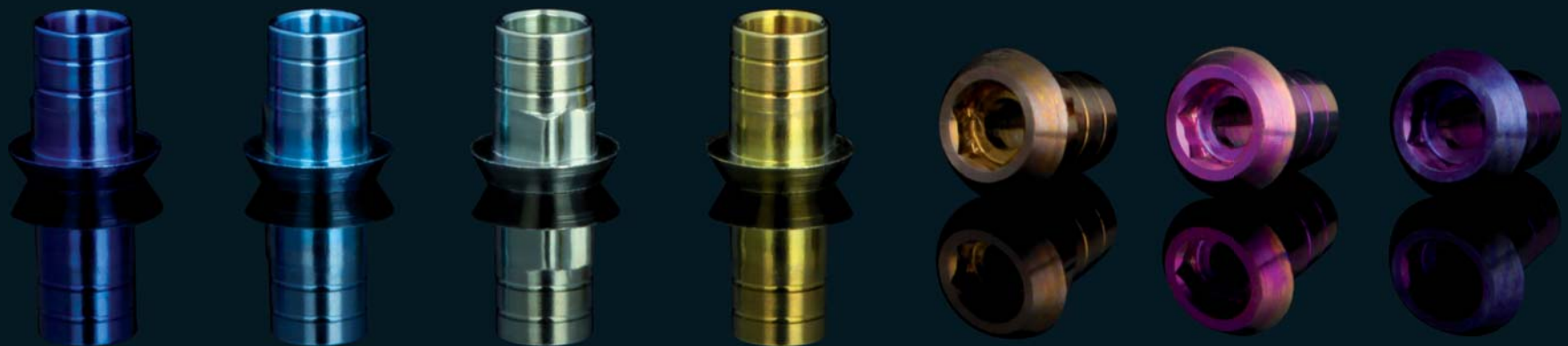

CONICAL CEMENTED TITANIUM BASE NON HEX

Our Conical Cemented Titanium Bases NON HEX without anti-rotation device are ideal for the manufacturing of bridges and multi-unit restorations. The titanium bases are designed as short and conical as possible. Spiral grooves located on the surface increase the contact area and ensure optimum adhesion of the cement.



For multi-unit restorations



Conical shape with spiral grooves



Also available gold-plated for increased biocompatibility and reduced grey values



Without anti-rotation device



Available in different gingival heights



PARALLEL CEMENTED TITANIUM BASE HEX

Our Parallel Cemented Titanium Bases HEX are equipped with the required anti-rotation device depending on the implant system. This ensures that restorations can no longer be twisted once they are cemented. They are especially suitable for single crowns.

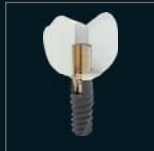

For single crowns



Parallel shaft



Also available gold-plated for increased biocompatibility and reduced grey values



With anti-rotation device



Available in different gingival heights



PARALLEL CEMENTED TITANIUM BASE HEX

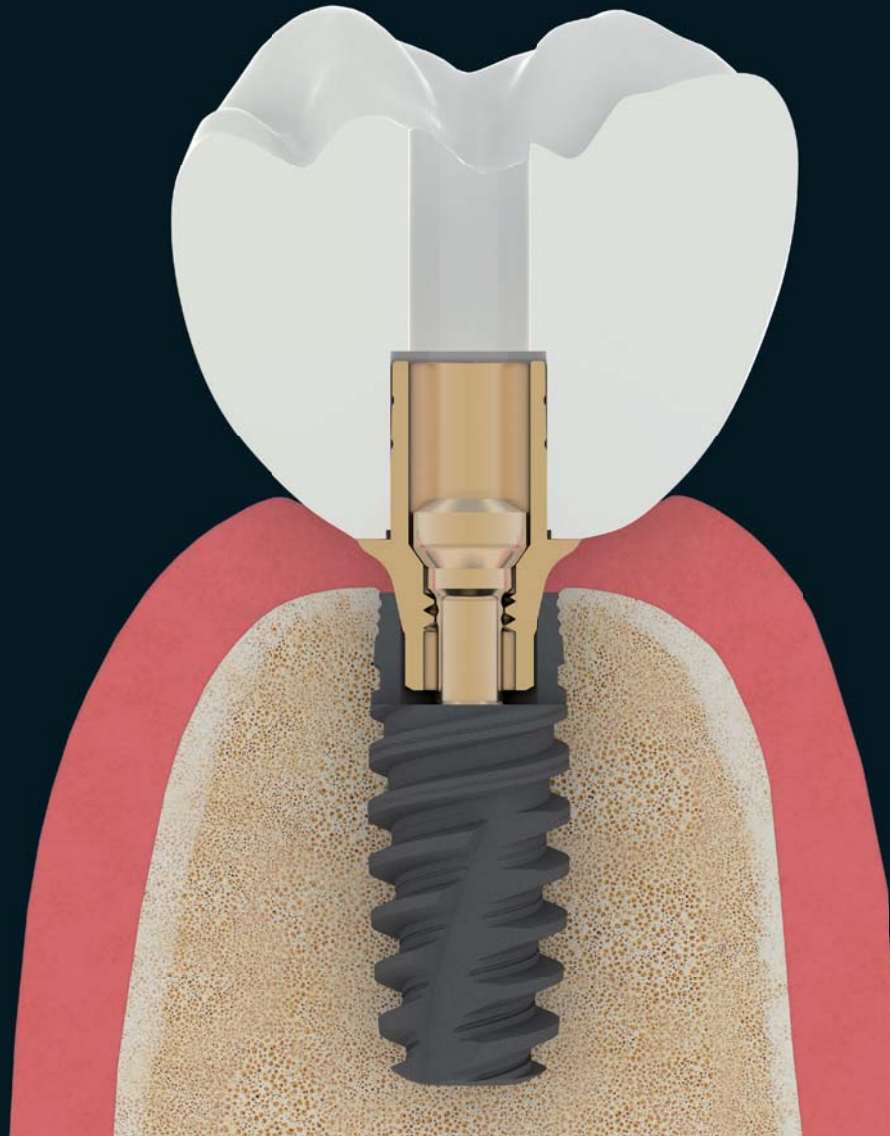

NARROW TITANIUM BASE HEX

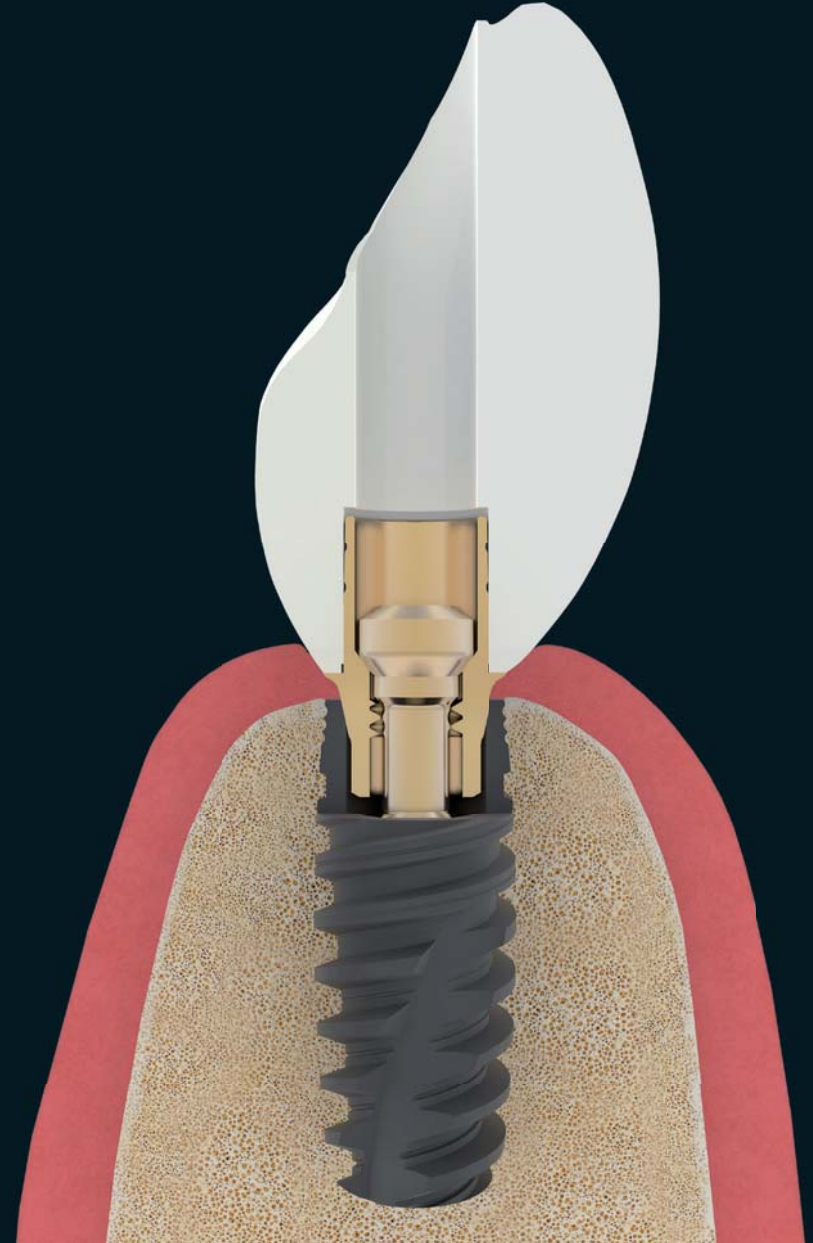

NARROW TITANIUM BASE

Narrow Titanium Bases are especially advantageous for implants on bone level, since their platform diameter is minimised. This helps to prevent bone atrophy. Thanks to their reduced gingiva height, their metal structure is not visible under the restoration, even if the gingival level is very low or in case of gingival atrophy. They are especially suitable for implants placed closely in the anterior sector where little space is available.



NARROW TITANIUM BASE NON HEX

Thanks to their reduced geometry, Narrow Titanium Bases NON HEX without anti-rotation device are perfectly suitable for multi-unit structures on implants placed very closely to each other.



For multi-unit restorations



Conical shape with spiral grooves

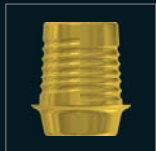

Also available gold-plated for increased biocompatibility and reduced grey values



Without anti-rotation device



NARROW TITANIUM BASE HEX

Narrow Titanium Bases HEX with anti-rotation device are characterised by their reduced geometry and therefore a perfect solution for single crowns placed next to each other in the anterior tooth region where little space is available.

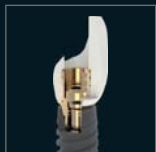

For single crowns



Parallel shaft



Also available gold-plated for increased biocompatibility and reduced grey values



With anti-rotation device

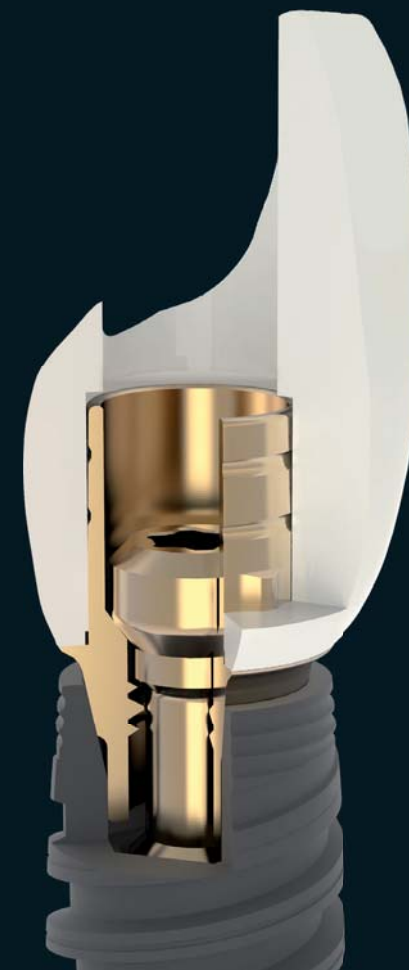

TITANIUM BASE K85

Our Titanium Bases K85 can be shortened and adjusted individually according to the tooth length, ensuring optimum force distribution. This makes them particularly stable, since the titanium base can be placed deeply into the tooth restoration. These titanium bases are available with conical and parallel shafts, also gold-plated.

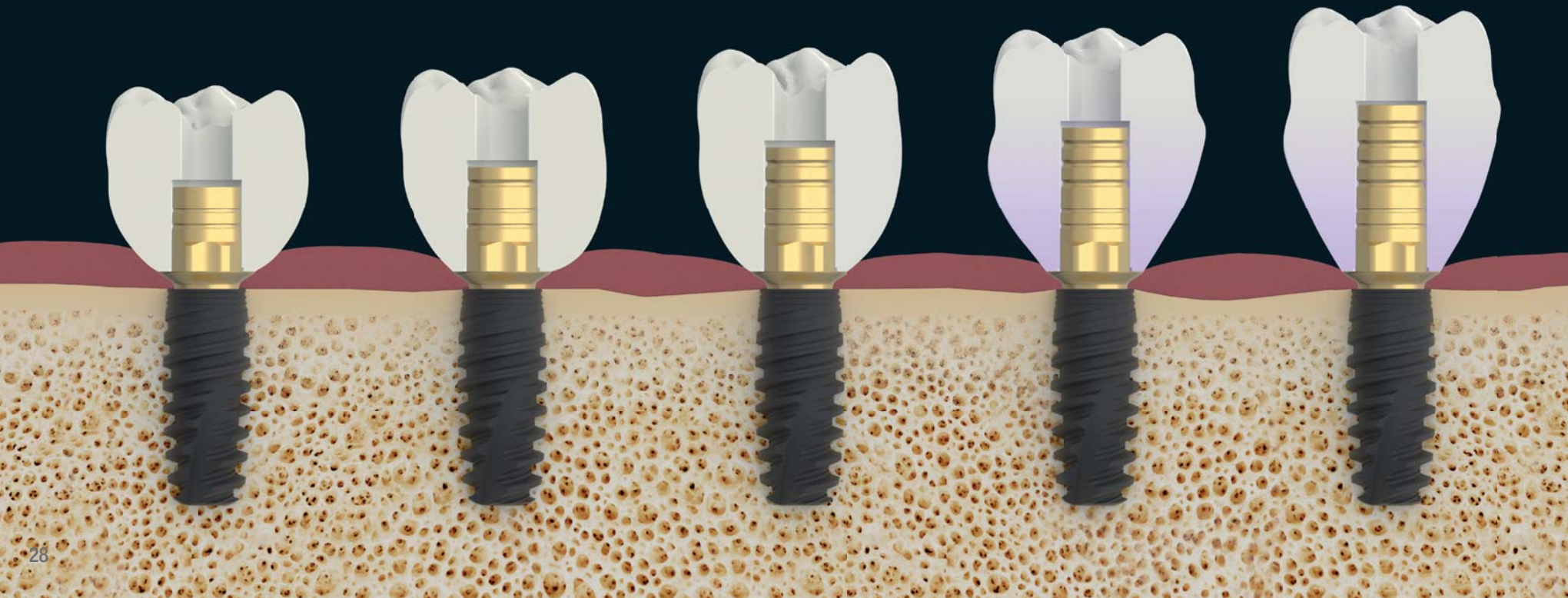

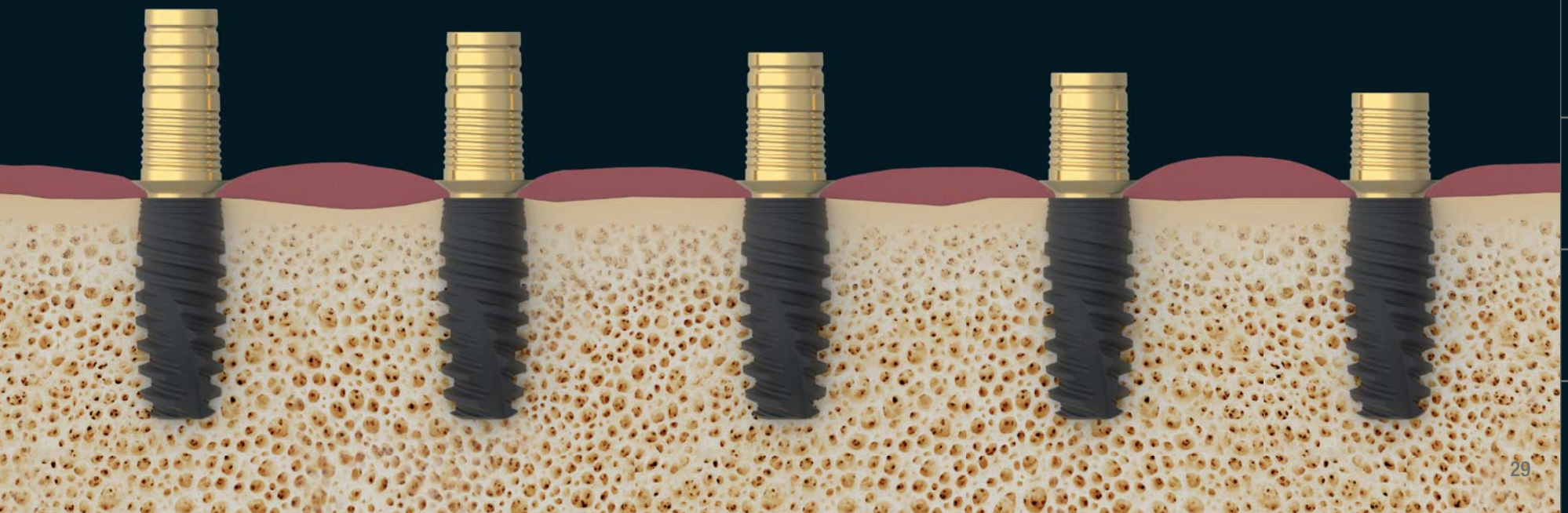

CONICAL CEMENTED TITANIUM BASE NON HEX K85

Conical Cemented Titanium Bases NON HEX K85 without anti-rotation device are ideal for the manufacture of bridges and multi-unit restorations. Spiral grooves located on the surface increase the contact area and ensure optimum adhesion of the cement.



For multi-unit restorations



*Conical shape with spiral grooves;
adjustable height*



*Also available gold-plated for increased
biocompatibility and reduced grey values*



Without anti-rotation device



Available in different gingival heights



PARALLEL CEMENTED TITANIUM BASE HEX K85

Our Parallel Cemented Titanium Bases HEX K85 are equipped with the required anti-rotation device depending on the implant system. This ensures that restorations can no longer be twisted once they are cemented. They are especially suitable for single crowns.



For single crowns



Parallel shaft; adjustable height



Also available gold-plated for increased biocompatibility and reduced grey values



With anti-rotation device



Available in different gingival heights



ABUTMENT SCREW METAL

This abutment screw is suitable to fix titanium bases, Scanmarkers and Raw-Abutments®, but not for zirconia structures.



For titanium bases, Scanmarkers and metal structures with direct connection, not for zirconia abutments



With conical or flat screw head



Available gold-plated for increased biocompatibility; gold-plating prevents cold welding as well as the unintended loosening of the screw



Abutment Screw Black: screw for the final restoration in the patient's mouth



Abutment Screw Laboratory: provisional screw for fixing the structure on the model

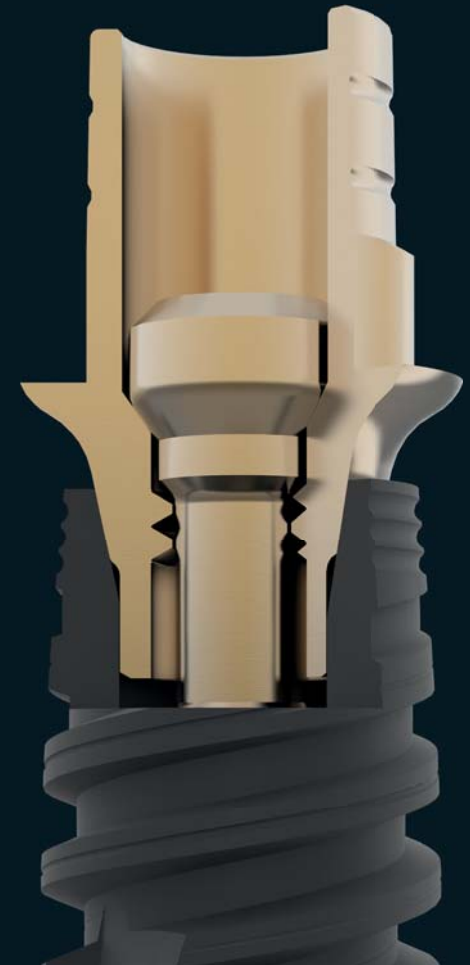

ABUTMENT SCREW ZIRCONIA

This abutment screw with flat screw head is ideal for directly screwed zirconia or resin structures. However, we generally recommend the use of titanium bases for all implant-supported restorations.



For individual abutments made from zirconia and resin



With flat screw head



Available gold-plated for increased biocompatibility; gold-plating prevents cold welding as well as the unintended loosening of the screw



Abutment Screw Black: screw for the final restoration in the patient's mouth



Abutment Screw Laboratory: provisional screw for fixing the structure on the model



APPLICATION

Titanium bases, Raw-Abutments® and Scanmarkers can be fixed onto the implant using the Abutment Screw Metal. On full-contour zirconia abutments, screws with flat seating must be used in order to avoid tensions in the zirconia, which, in the worst case can lead to cracks in the abutment.



or



ABUTMENT SCREW METAL

The screw head can be conical or flat, depending on the implant system

only



ABUTMENT SCREW ZIRCONIA

Only with flat screw head for monolithic zirconia and resin

RIGHT

Abutment Screw
Zirconia



Zirconia
abutment



Implant



RIGHT

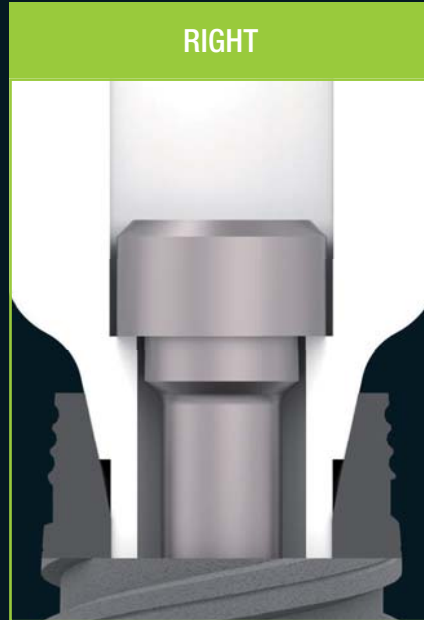

WRONG

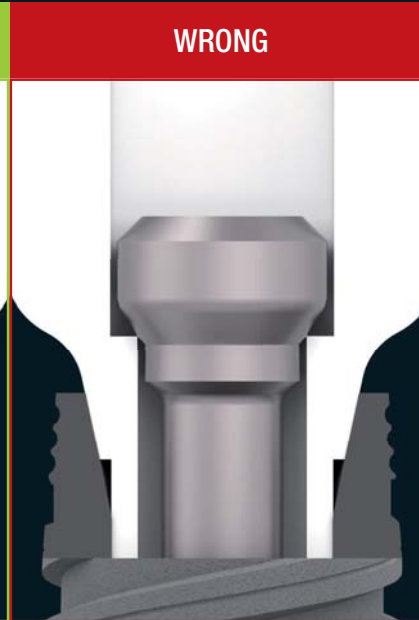

WRONG



Abutment Screw
Metal

Zirconia
abutment

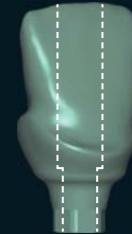

Implant



RAW-ABUTMENT® HEX

Our Raw-Abutments® are made from ASTM-approved titanium grade 5. They enable the manufacture of customised one-piece abutments thanks to their industrially prefabricated implant connections, which guarantee the highest precision and fitting accuracy. The special milling strategies and milling burs ensure a particularly smooth surface structure. Depending on the implant system, different Raw-Abutment® blanks are required.



For single crowns



With anti-rotation device



Available with 10 mm and 14 mm diameter



Can be anodised in different colours with the Titanium Spectral-Colouring Anodizer or the Metal Colourizer

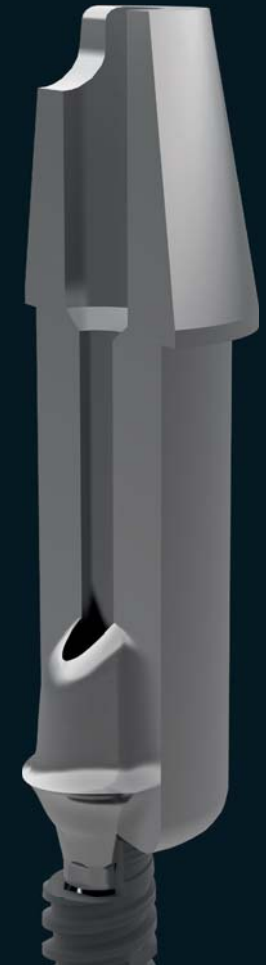

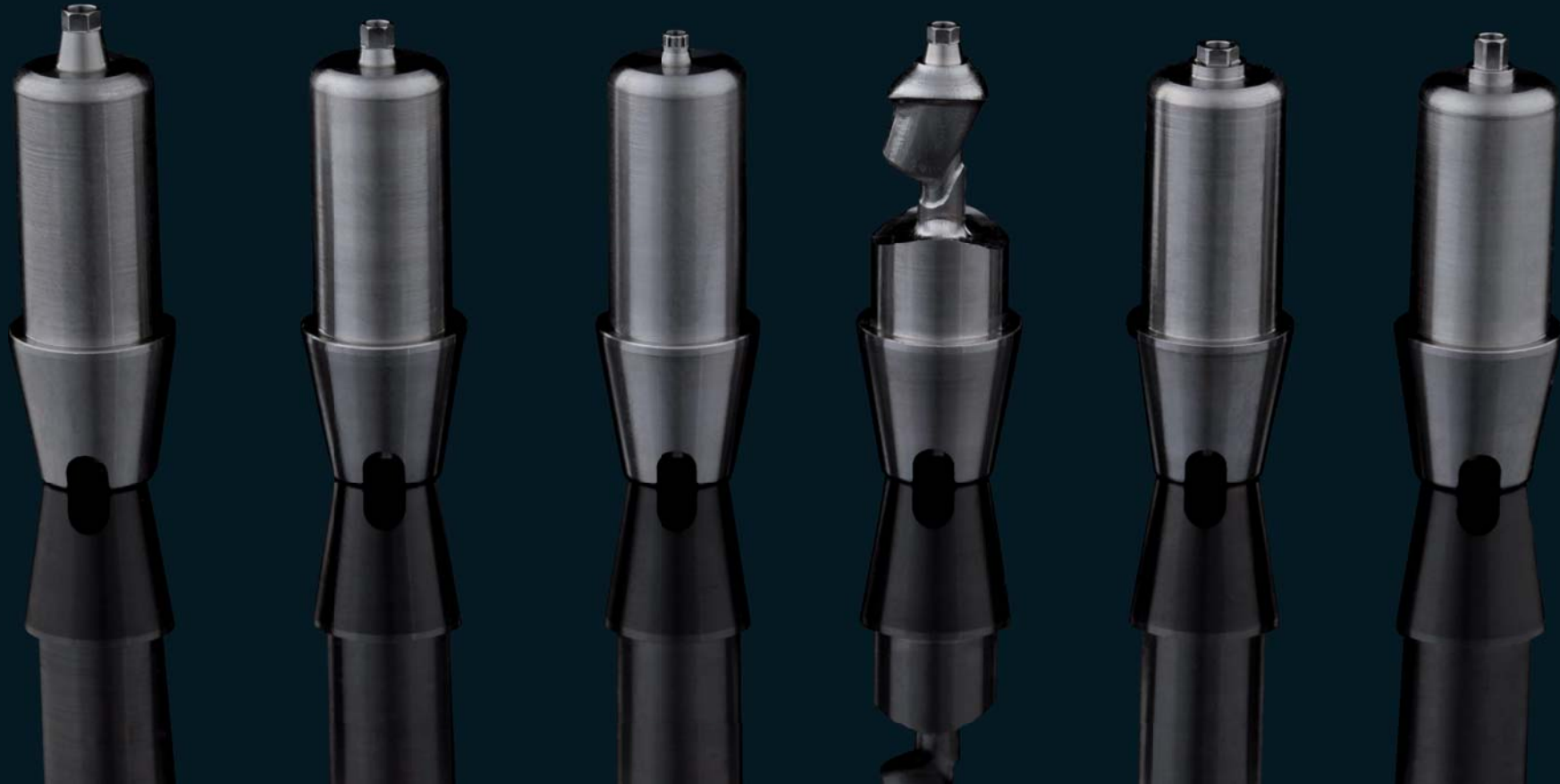

ZIRKONZAHN MULTI UNIT ABUTMENTS

Zirkonzahn Multi Unit Abutments and Multi Unit Abutments Angled are especially suited for multi-unit restorations. Due to the fact that they are adapted to different implant systems and their connections for the secondary structure are unified, the secondary structure can be screwed directly, or with additional titanium bases, with different implants without any problems. A further advantage of the standardised connection is that using these abutments, also other components (e.g. titanium bases, Scanmarkers...) are reduced to one connection and divergences are compensated.

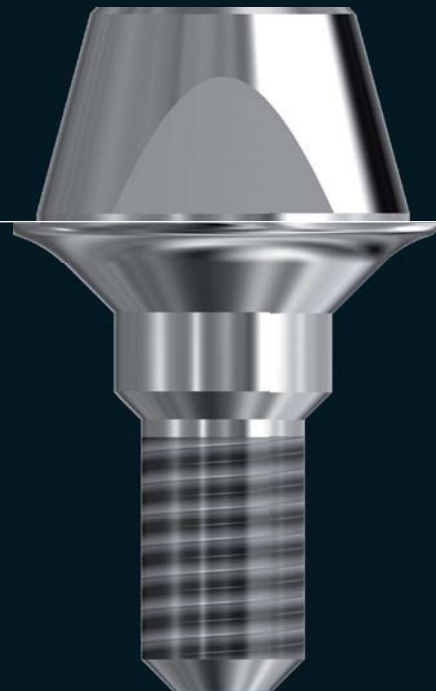

ZIRKONZAHN MULTI UNIT
ABUTMENT NON HEX



ZIRKONZAHN MULTI UNIT
ABUTMENT 17°

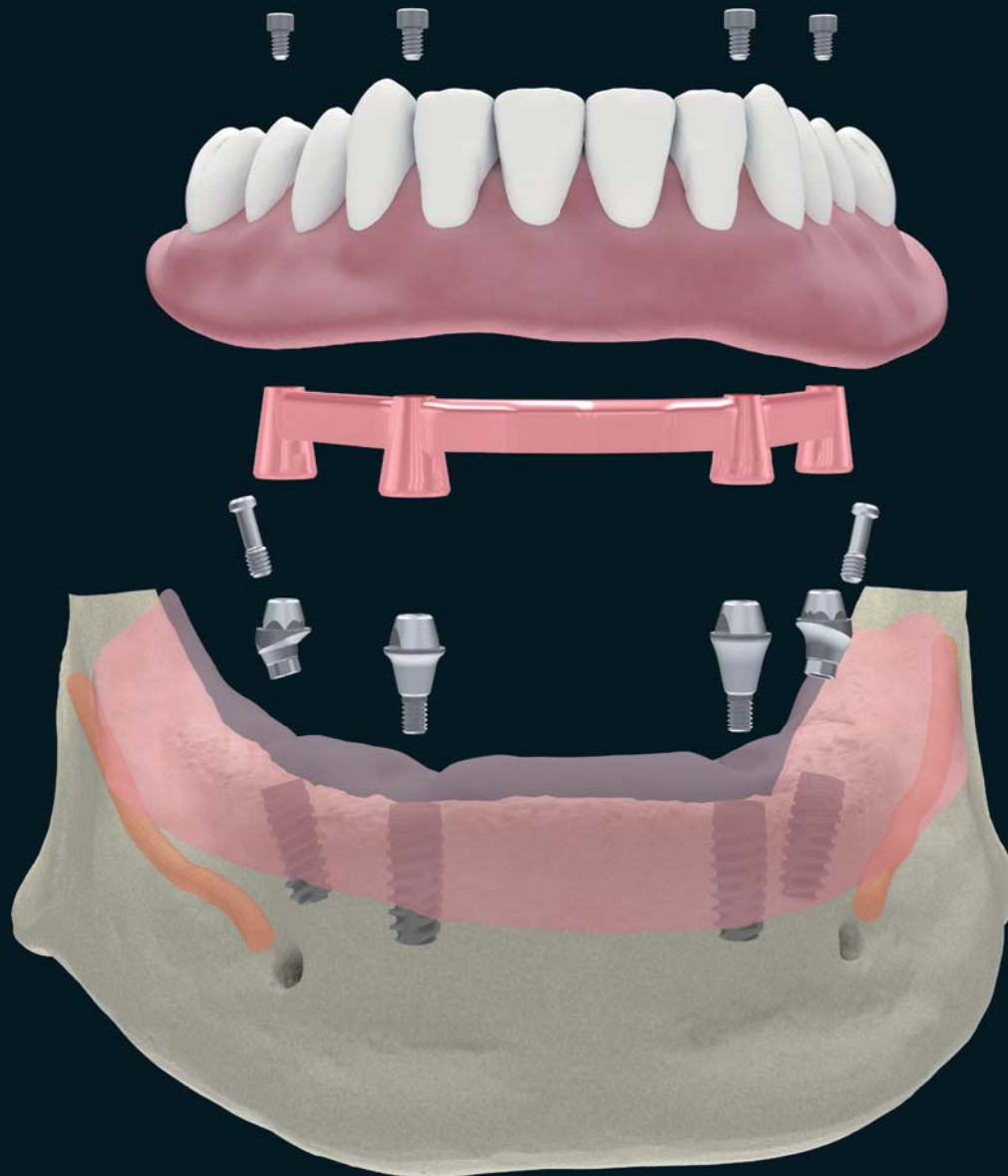

Restoration fixed on two Multi Unit Abutments and two Multi Unit Abutments Angled 17° which permit to compensate the implants' diverging axes.

FOR MULTI-UNIT RESTORATIONS

NON HEX



Conical Cemented Titanium Base NON HEX + Abutment Screw Metal



Multi Unit Abutment NON HEX + Abutment Screw Metal

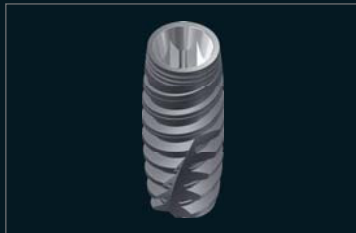

Implant

FOR SINGLE CROWNS

HEX



Narrow Titanium Base HEX Six Position + Abutment Screw Metal



Narrow Titanium Base HEX One Position + Abutment Screw Metal



Multi Unit Abutment 17° HEX + Implant Screw + Insertion Tool



Implant

COMMON COMPONENTS



Impression coping



Healing Cap anodised in pink colour

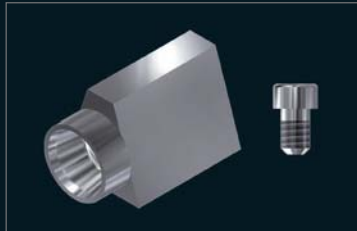

Scanmarker + Abutment Screw Metal



White Scanmarker + Abutment Screw Metal



Laboratory Analogue



ScanAnalogue

TOOLS



Screwdriver 0,05" short



Torque Ratchet Wrench



Screwdriver 0,05" medium



Screw Driver Zirkonzahn MUA



Screwdriver 0,05" long

ZIRKONZAHN MULTI UNIT ABUTMENT NON HEX

Multi Unit Abutments NON HEX without anti-rotation device are suited for multi-unit restorations. They are designed in one piece to prevent bacteria proliferation. The application of Multi Unit Abutments NON HEX is extremely easy, because all types of implants have been adapted on a standard port. They are available in five different gingival heights to offer the best possible solution for every case.



For multi-unit restorations



Conical Cemented Titanium Base as component of the Multi Unit Abutment



Without anti-rotation device



Also available gold-plated for increased biocompatibility and reduced grey values



Available in different gingival heights



ZIRKONZAHN MULTI UNIT ABUTMENT ANGLED HEX

Zirkonzahn Multi Unit Abutments are available with a 17° angle and two differently angled hex-implant connections to compensate any inclinations of the implants. They can be used for single crowns and multi-unit restorations.



For single crowns and multi-unit restorations



Conical Cemented Titanium Base, Parallel Cemented Titanium Base and Parallel Cemented Titanium Base One Position as components of the Multi Unit Abutment Angled HEX. The One Position titanium bases are used to screw single crowns on Multi Unit Abutments 17° with anti-rotation device



With anti-rotation device



Also available gold-plated for increased biocompatibility and reduced grey values



Available in different gingival heights

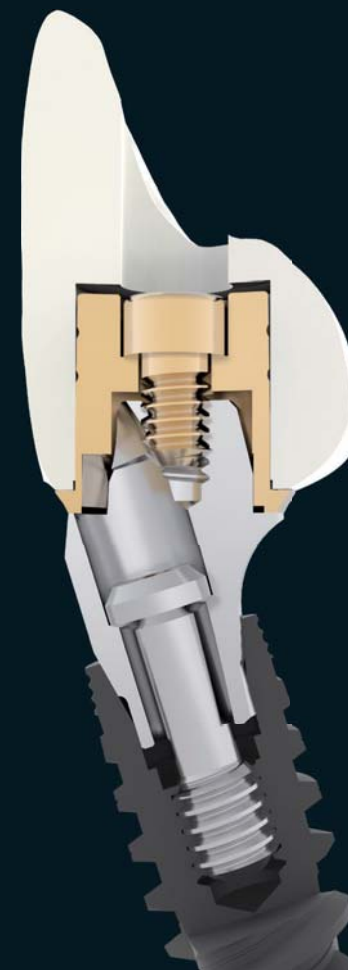

CONNECTION POSSIBILITIES WITH MULTI UNIT ABUTMENTS

Depending on the position of the implant, with the two different connection types (1 and 2) the number of connection possibilities has doubled.

Side view

Top view

The MUA can be positioned on every 60° of a HEX connection.

Having the possibility to choose between two different connection types, the MUA can be positioned on every 30° of a HEX connection.

*HEX connection
Type 1*

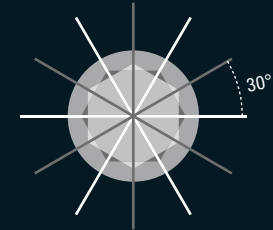
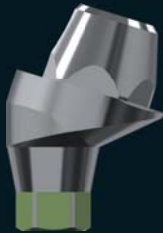

*HEX connection
Type 2*

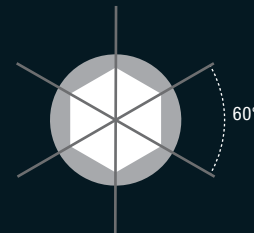

Triangular connection
Type 1

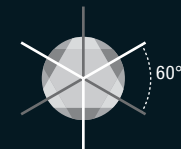
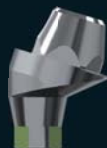

Triangular connection
Type 2

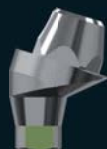

Square connection
Type 1

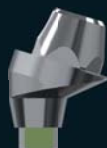

Square connection
Type 2



Octagonal connection
Type 1

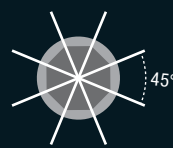

Octagonal connection
Type 2



ZIRKONZAHN LOC-CONNECTOR

Zirkonzahn LOC-Connector is a snap attachment system for implants and bars that is used to connect complete overdentures to dental implants. Zirkonzahn LOC-Connectors combine the advantages of removable and fixed prostheses and their snap-on mechanism allows both patients and dentists to insert and remove the restoration. They can be used for bridges only and are available both upright (for Multi Unit Abutments and implants) and oblique (for implants only).

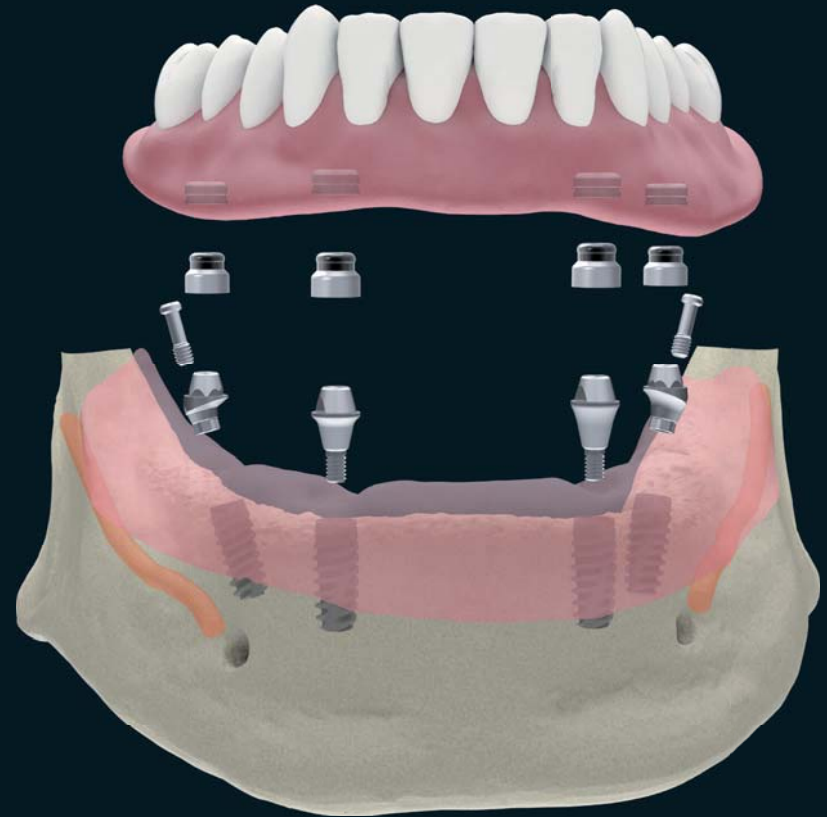

Zirkonzahn LOC-Connectors on Zirkonzahn Multi Unit Abutments

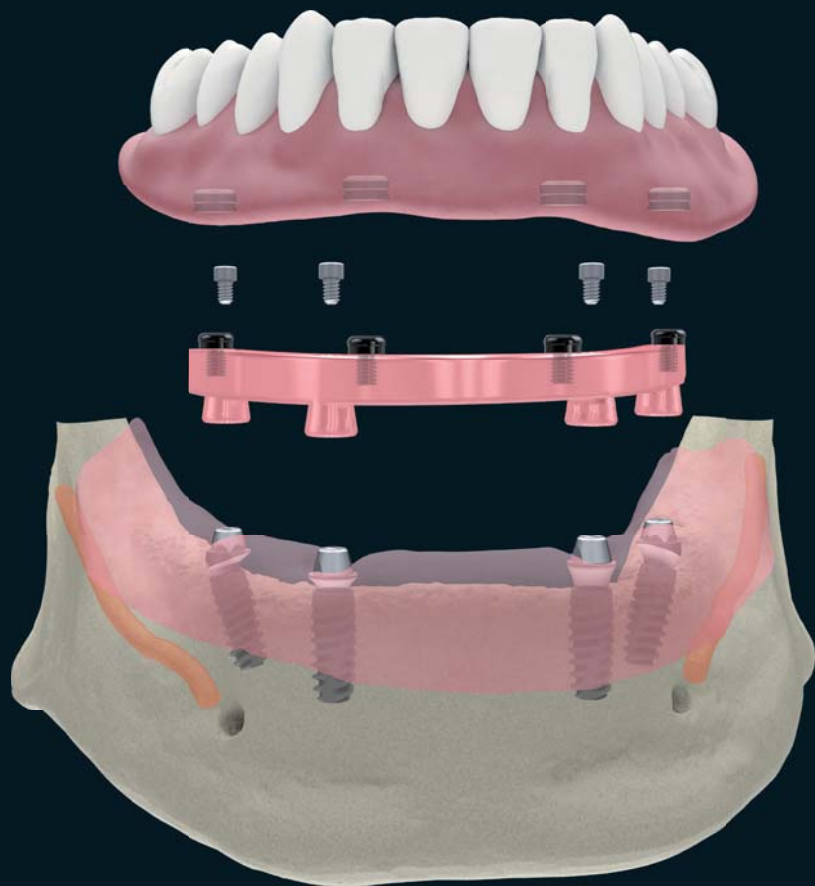

Zirkonzahn LOC-Connectors on a titanium bar

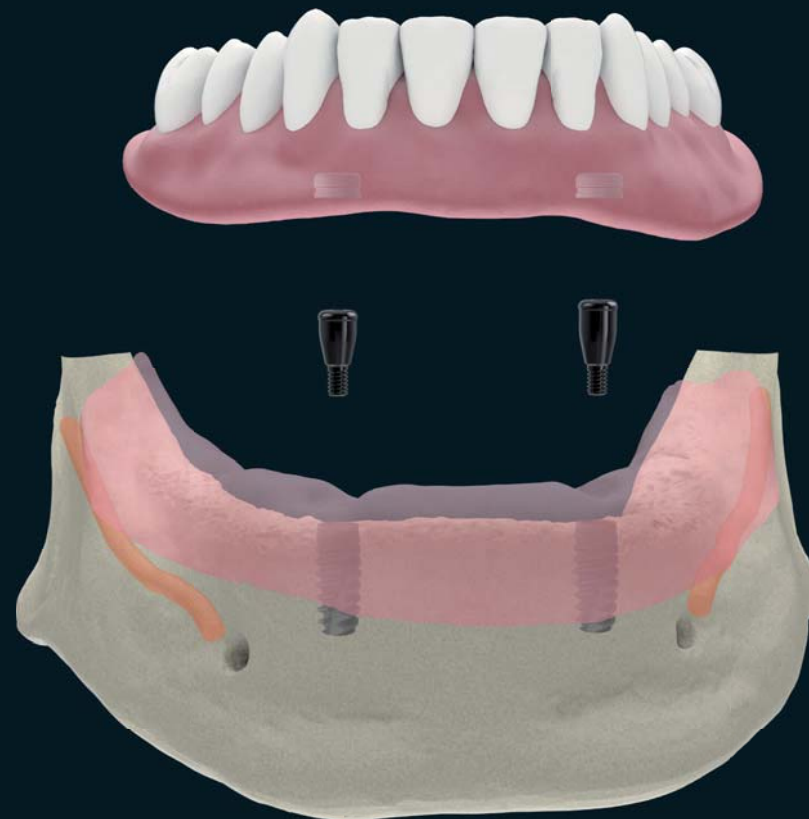

Zirkonzahn LOC-Connectors directly on implants

ZIRKONZAHN TITANIUM POSTS

Zirkonzahn Titanium Posts, made with Titan 5, are used to reconstruct teeth with extensive coronal defects. In combination with specific scanmarkers, using an intraoral scanner, it is possible to determine the posts' position and inclination in order to make them available in the design software for the subsequent working steps.

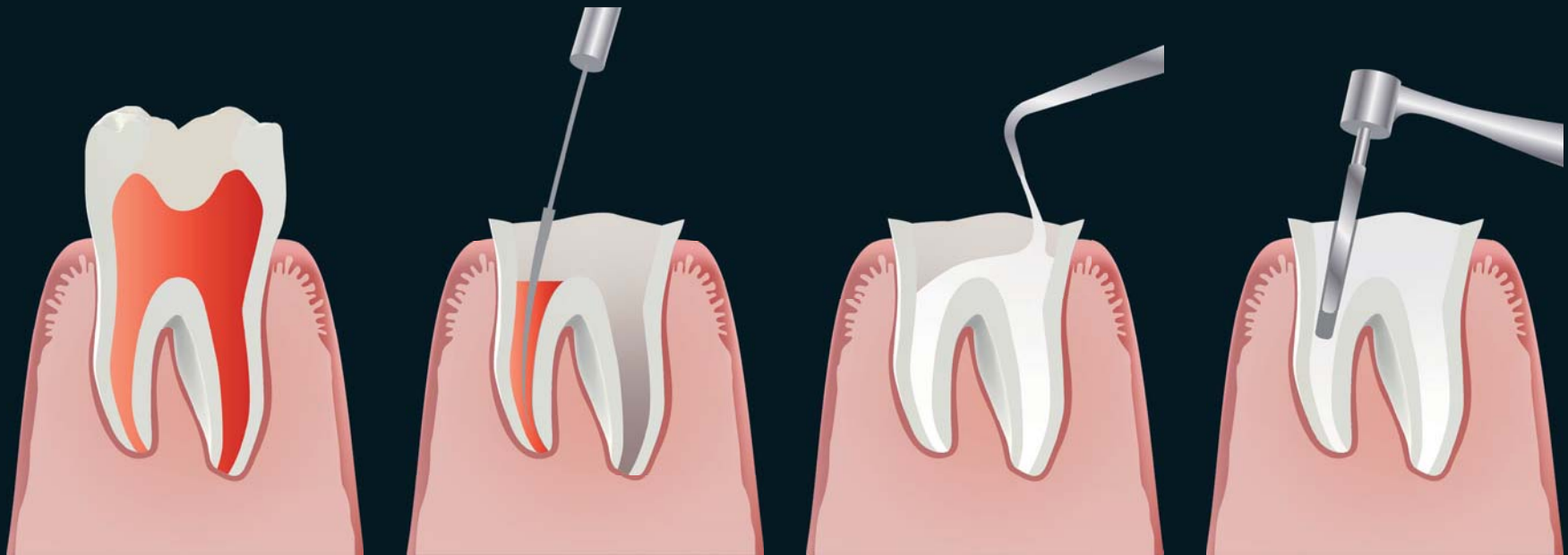

Inflamed tooth

*The nerves are removed and the
canals are cleaned*

*The root is filled with a special
filling material*

Drilling the root canal



Preparing the post canal



Insertion of the posts together with scanmarkers for intraoral scanning



Shortening the titanium post; insertion of the crown, designed with a fixed post



Sealing the post canal in the crown

TOOLS

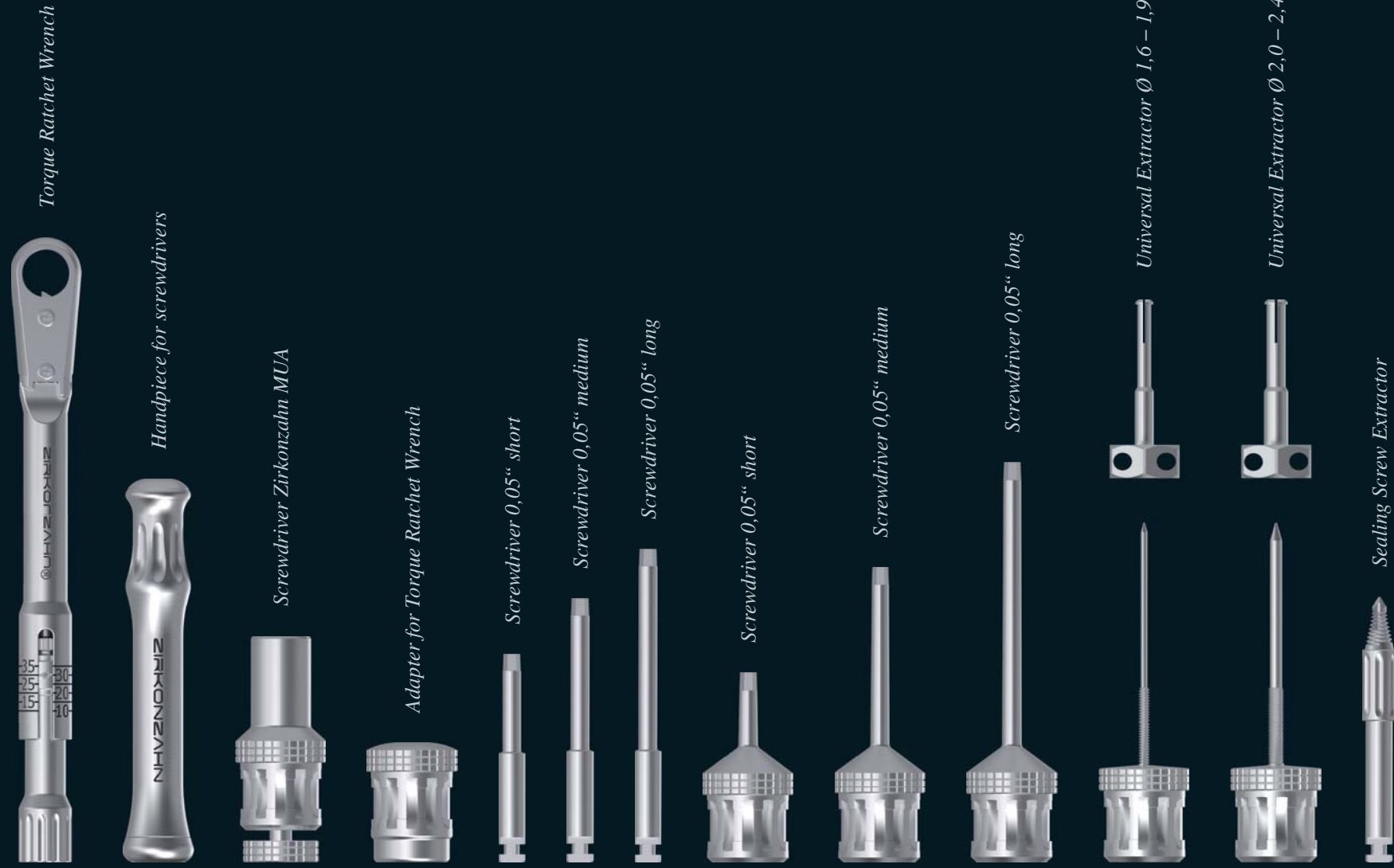

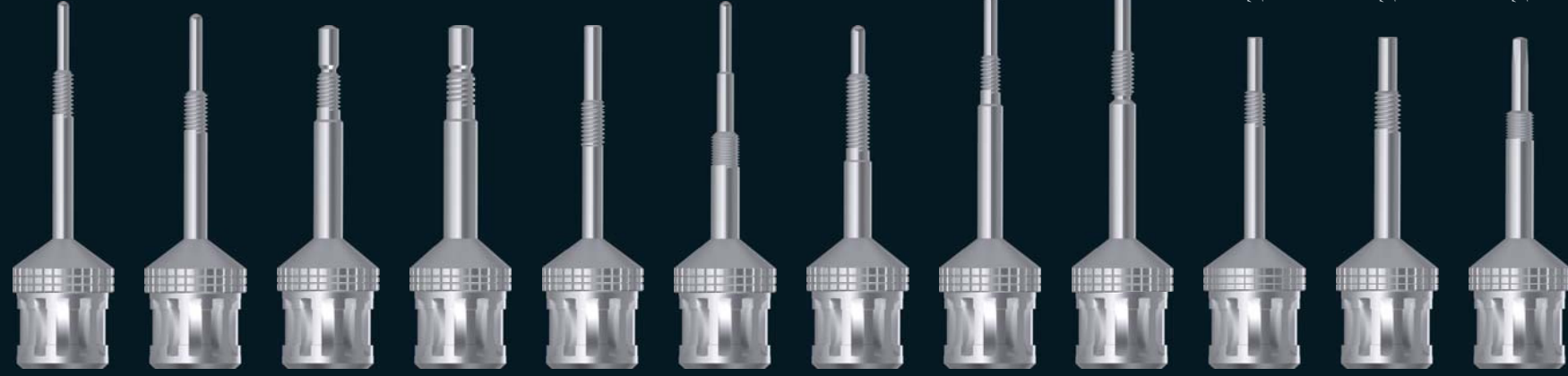

Titanium Base Extractor Biotech 3.0

Titanium Base Extractor Biotech 3.6-5.4

Titanium Base Extractor Camlog Conelog 3.3-4.3

Titanium Base Extractor Camlog Conelog 5.0

Titanium Base Extractor Friadent Dentsply Ankylos 3.5-7.0

Titanium Base Extractor K3 Mini

Titanium Base Extractor K3 Standard

Titanium Base Extractor MIS Narrow

Titanium Base Extractor MIS Standard/Wide

Titanium Base Extractor Nobel Biocare Nobel Active NP

Titanium Base Extractor Nobel Biocare Nobel Active RP/WP

Titanium Base Extractor Tekka In-Kone 3.5-5.5

TITANIUM BASE EXTRACTOR

Abutments are fitted to laboratory analogues or implants directly on the model or in the patient's mouth and then screwed. If the abutment is fixed on an implant with a flat-angled connection, a frictional connection is created. In the conventional manual way, the two components cannot be separated from each other without sustaining some damage. By using the Titanium Base Extractor this is possible without overstressing the osseointegrated parts.

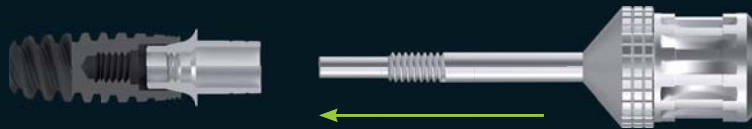

The Titanium Base Extractor is screwed into the internal thread of the abutment ...

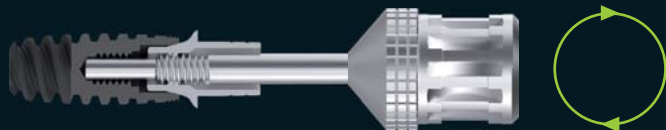

... until the bottom of the implant is reached.

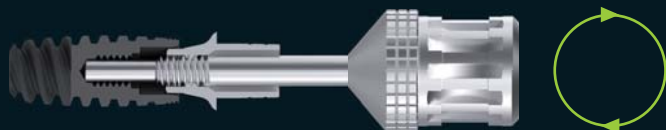

A further screwing ...



... ensures a gentle removal of the abutment from the implant or laboratory analogue

UNIVERSAL EXTRACTOR

The Universal Extractor is used to remove directly screwed secondary structures (e.g. made of metal or resin) as well as titanium bases without internal threads from implants with flat-angle connection geometries.



UNIVERSAL SCREWDRIVER SET

Set for all types of restorations including the new Torque Ratchet Wrench, the Ratchet Wrench Adapter and several screwdrivers available for different implant systems and lengths.

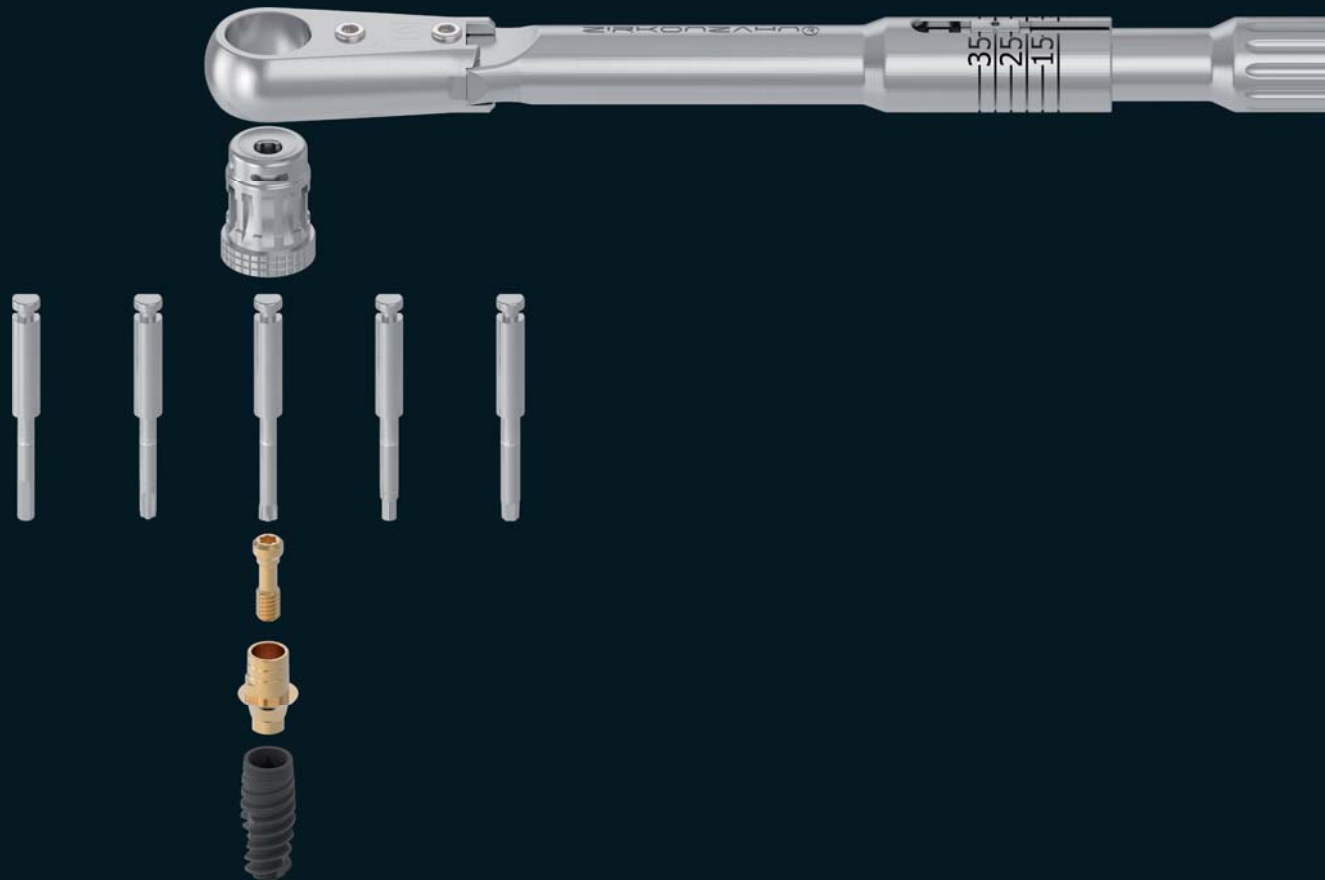



ZIRKONZAHN

RATCHET WRENCH
ZIRKONZAHN

SCREWDRIVER ZIRKONZAHN FOR MUA

The screwdrivers are used in combination with the Torque Ratchet Wrench to fix the titanium bases and MUAs. The screwdrivers are available in different sizes.

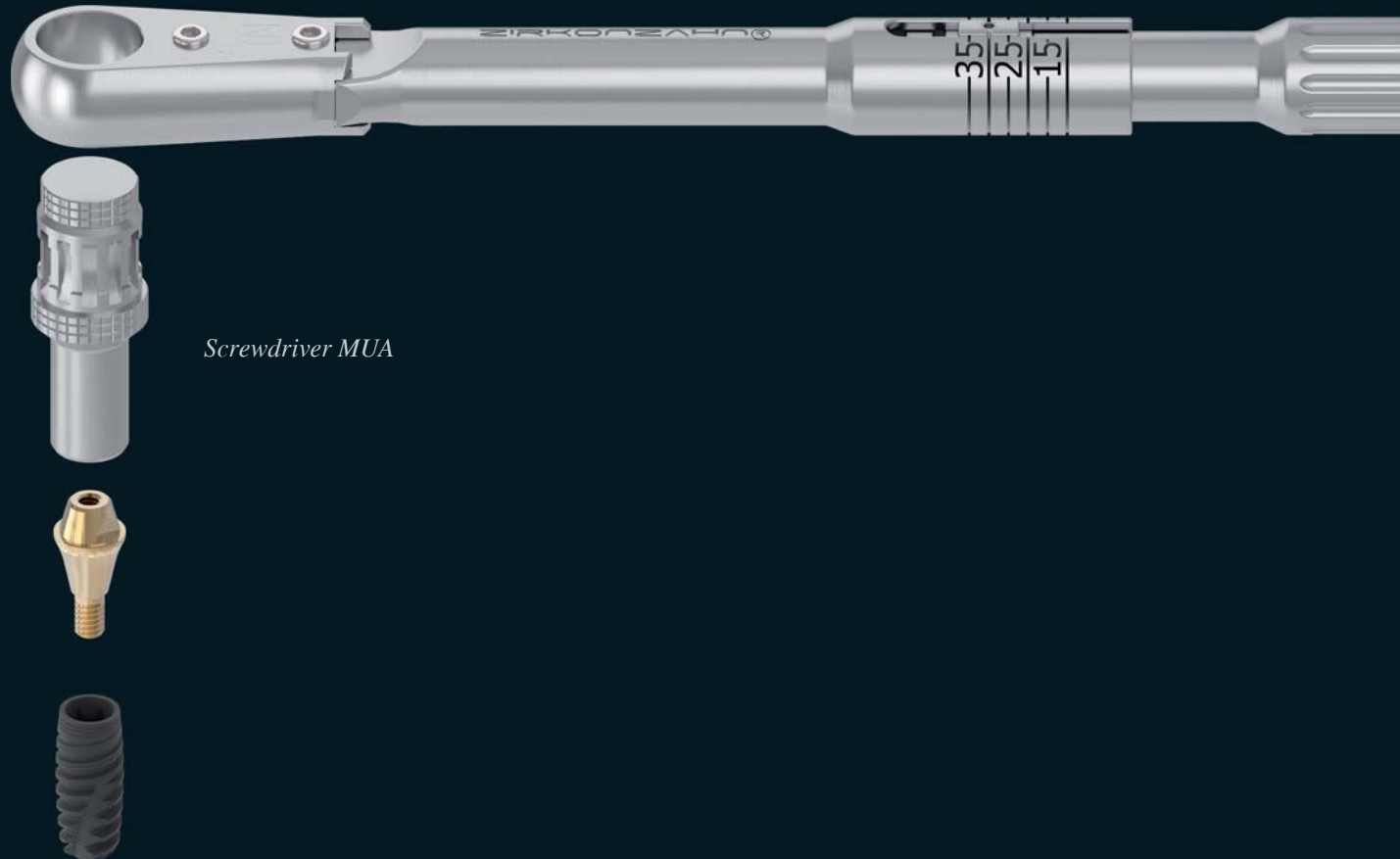







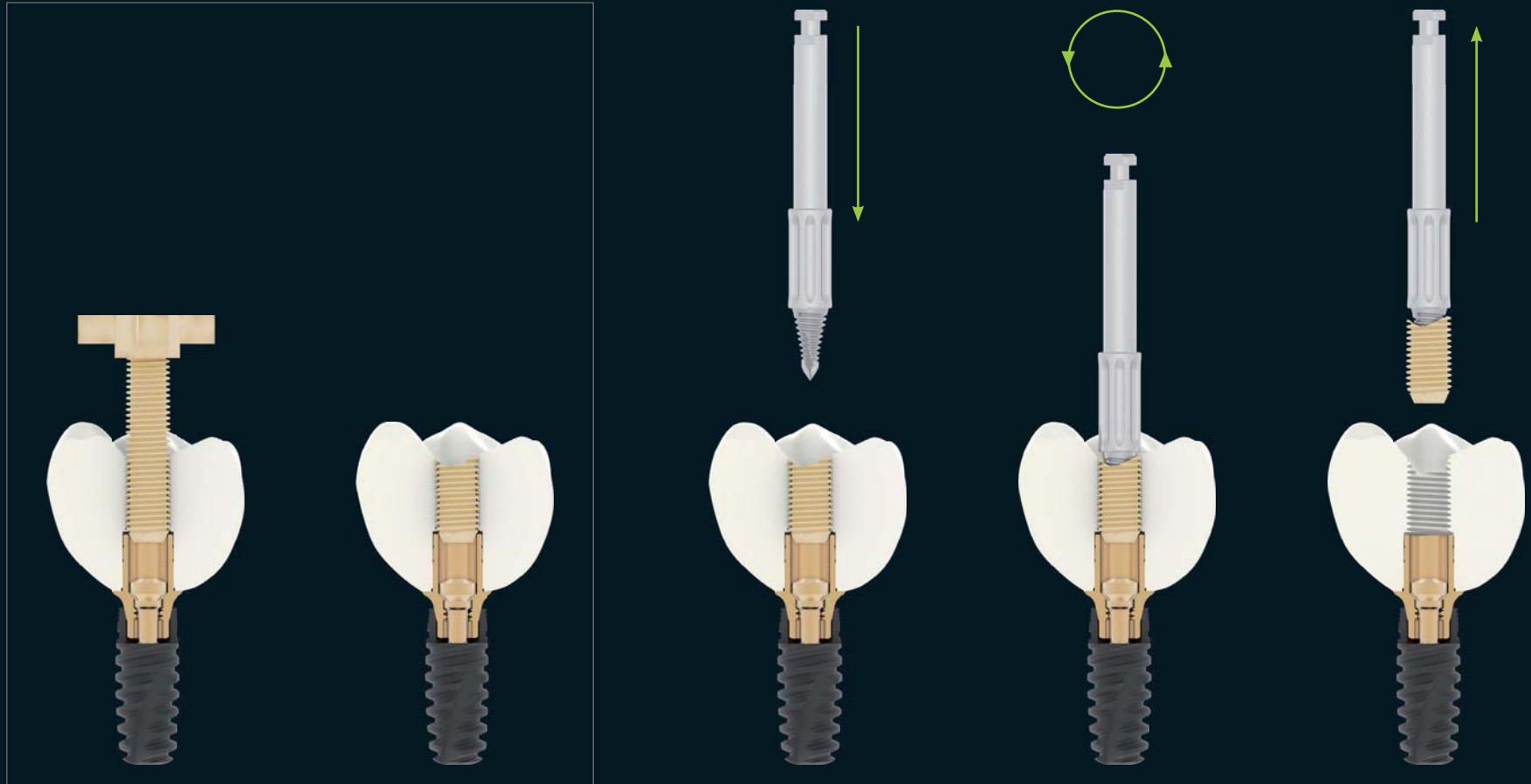



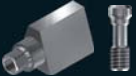

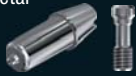







Screwdriver MUA

SEALING SCREW EXTRACTOR

The Sealing Screw Extractor can be used to loosen sealing screws out of zirconia structures without damaging the threaded screw channel.



AVAILABLE SETS

ANALOGUES	SCANMARKER	TRANSFER	RAW-ABUTMENTS®	TITANIUM BASES			
<p>Laboratory Analogue</p> 	<p>Scanmarker + Abutment Screw Metal</p> 	<p>Impression coping</p> 	<p>Raw-Abutment® HEX + Abutment Screw Metal</p> 	<p>Narrow Titanium Base HEX + Abutment Screw Metal</p> 	<p>Narrow Titanium Base HEX Gold + Abutment Screw Metal Gold</p> 	<p>Parallel cemented titanium base HEX + Abutment Screw Metal</p> 	<p>Parallel cemented Titanium Base HEX Gold + Abutment Screw Metal Gold</p> 
<p>Zirkonzahn LOC-Connector</p> 	<p>White Scanmarker + Abutment Screw Metal</p> 		<p>Raw-Abutment® D14 HEX + Abutment Screw Metal</p> 	<p>Narrow Titanium Base NON HEX + Abutment Screw Metal</p> 	<p>Narrow Titanium Base NON HEX Gold + Abutment Screw Metal Gold</p> 	<p>Conical cemented Titanium Base NON HEX + Abutment Screw Metal</p> 	<p>Conical Cemented Titanium Base NON HEX Gold + Abutment Screw Metal Gold</p> 
	<p>White Metal Scanmarker</p> 					<p>Parallel cemented titanium base HEX K85+ Abutment Screw Metal</p> 	<p>Parallel cemented Titanium Base HEX K85 Gold + Abutment Screw Metal Gold</p> 
<p>ScanAnalog</p> 						<p>Conical cemented Titanium Base NON HEX K85+ Abutment Screw Metal</p> 	<p>Conical Cemented Titanium Base NON HEX K85 Gold + Abutment Screw Metal Gold</p> 

SCREWS

TOOLS

Abutment Screw Metal



Abutment Screw Metal Gold



Abutment Screw Metal Laboratory



Abutment Screw Metal Black



Screwdriver



Torque Ratchet Wrench



Universal Extractor or Titanium Base Extractor



Abutment Screw Zirconia



Abutment Screw Zirconia Gold



Abutment Screw Zirconia Laboratory

















Abutment Screw Zirconia Black

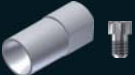





















Sealing Screw Extractor



AVAILABLE SETS ZIRKONZAHN MUA

ANALOGUES	SCANMARKER	TRANSFER	HEALING CAPS	MULTI UNIT ABUTMENT		TITANIUM BASES
<p>Laboratory Analogue</p> 	<p>Scanmarker + Abutment Screw Metal</p> 	<p>Impression coping</p> 	<p>Healing Cap Grey; anodisable</p> 	<p>Multi Unit Abutment NON HEX + Abutment Screw Metal</p> 	<p>Multi Unit Abutment NON HEX Gold + Abutment Screw Metal Gold</p> 	<p>Conical cemented Titanium Base NON HEX + Abutment Screw Metal</p> 
	<p>White Scanmarker + Abutment Screw Metal</p> 		<p>Healing Cap golden; anodised</p> 	<p>Multi Unit Abutment 17° HEX + Implant Screw + Insertion Tool</p> 	<p>Multi Unit Abutment 17° HEX Gold + Implant Screw Gold + Insertion Tool</p> 	<p>Narrow Titanium Base HEX + Abutment Screw Metal</p> 
<p>ScanAnalog</p> 			<p>Healing Cap pink; anodised</p> 			<p>Narrow Titanium Base HEX One Position + Abutment Screw Metal</p> 

TITANIUM BASES	SCREWS				TOOLS	
Conical Cemented Titanium Base NON HEX Gold + Abutment Screw Metal Gold 	Abutment Screw Metal 	Abutment Screw Metal Gold 	Abutment Screw Metal Laboratory 	Abutment Screw Metal Black 	Screw Driver Zirkonzahn MUA 	Screwdriver 
Narrow Titanium Base HEX Gold + Abutment Screw Metal Gold 	Abutment Screw Zirconia 	Abutment Screw Zirconia Gold 	Abutment Screw Zirconia Laboratory 	Abutment Screw Zirconia Black 	Torque Ratchet Wrench 	Titanium Base Extractor 
Narrow Titanium Base HEX One Position Gold + Abutment Screw Metal Gold 	Implant Screw 	Implant Screw Gold 	Implant Screw Laboratory 	Implant Screw Black 	Sealing Screw Extractor 	

ZIRKONZAHN.SOFTWARE

When developing the Zirkonzahn.Software we adapted the strict quality standards of our proven products to our software's design and functionality. The user's interface is clearly structured, has a simple design and is the same for each software component, which makes it the cornerstone for a familiar and reliable application. When it comes to the creation of different features, our developing team that includes also dental technicians follows a practical and result-oriented principle, which guarantees the greatest possible freedom of choice and processing. Furthermore, complex technological processes are designed in a comprehensive and transparent way. The different software programmes with the corresponding modules are not only matched to each other but also to the related hardware components. This ensures a 100% smooth work process for the dental technician and the dentist – from the patient data registration, articulation and restoration design and milling to the prostheses insertion in the patient's mouth. Proven manual and digital working techniques are combined in order to achieve the best possible patient care.



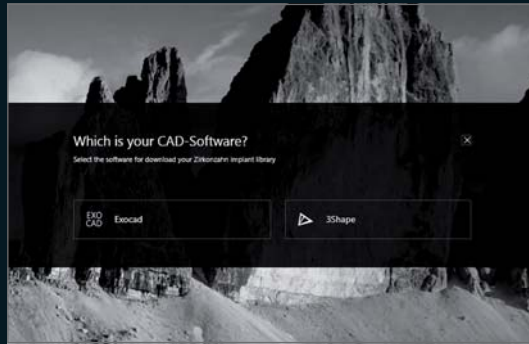

ZIRKONZAHN LIBRARY DOWNLOAD CENTER

- Zirkonzahn implant components for exocad® and 3shape users
- Free programme to import and manage all of Zirkonzahn's implant components in the 3shape or exocad® design software
- Fast download: implant libraries can be downloaded individually
- Always up to date: automatic update information for newly available systems or system components

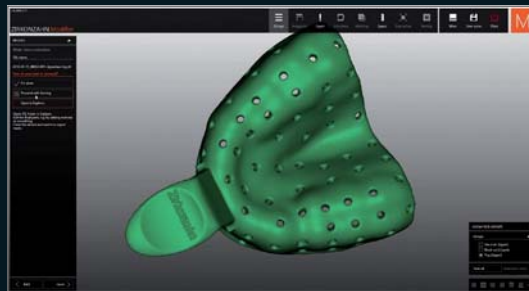

ZIRKONZAHN.TRAY SOFTWARE

- Free, stand-alone and intuitive software for the fabrication of individual impression trays designed based on model or intraoral scan data
- Open STL data format – compatible with various manufacturing processes (e.g. 3D printer) and systems
- Individual design possibilities (rims, dimensions, stoppers, holes), adjustable tool sizes for rapid design and material application, possibility to select various holders and holder sizes
- It can be downloaded for free on our website



HEROES COLLECTION VIRTUAL TOOTH LIBRARY

- Library including natural and aesthetic tooth sets (upper and lower jaws) as a base for the design of any kind of restoration, also for the creation of set-ups to be considered during the implants planning
- Rooted teeth set available

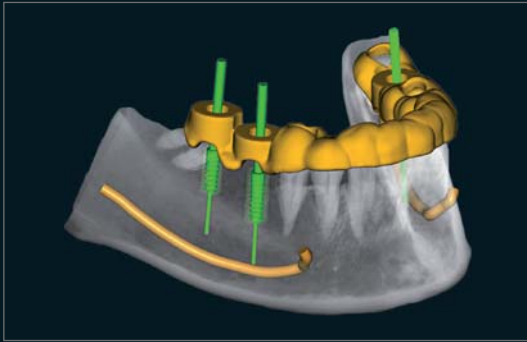

ZIRKONZAHN.IMPLANT-PLANNER SOFTWARE

With the Zirkonzahn.Implant-Planner, the cooperation between the dentist and the dental laboratory can be taken to new levels, reconciling the planned aesthetic design of a prosthetic restoration with the planned implant situation.

- *3D implant planning system approved as medical device*
- *Intuitive-to-use software with step-by-step guidance (Wizard)*
- *Compatible with different data formats (CBCT, CT, DCM, ...)*
- *Determining the ideal implant position based on bone density and patient individual data such as DICOM data, wax-up, intraoral and model scans as well as 3D facial scans. Manual adjustments are possible*
- *Conversion of DICOM data into STL data records for further processing with other CAD software (CAD/CAM STL-Converter software module required)*
- *Extensive implant libraries with varied implant-prosthetic components compatible with all common implant systems; library with a wide range of drilling sleeves. The libraries are being continually expanded*
- *Exporting the implant planning for further processing in the Zirkonzahn.Modellier software or another CAD software for planning the prosthetic restoration and the models with laboratory analogues. Manufacturing with Zirkonzahn CAD/CAM milling units, with CAD/CAM systems of other manufacturers or with 3D printers*
- *Creation of surgical guides, which can be either tooth-borne, bone-borne or mucosa-borne and that can be fixed with pins*
- *Creation of custom impression trays (CAD/CAM Z-Tray software module required)*
- *Free demo version available for free download (Zirkonzahn.Implant-Planner Viewer)!*



*Download for free
the demo version!*



ZIRKONZAHN.IMPLANT-PLANNER

Full version for the laboratory, with relevant tools for implant planning and for the production of surgical guides



ZIRKONZAHN.IMPLANT-PLANNER PRACTICE

Software version for the dental practice, with all relevant functions for implant planning only



ZIRKONZAHN.IMPLANT-PLANNER SOFTWARE MODULES (OPTIONAL)

CAD/CAM STL Converter software module – for converting DICOM data into STL data for the further processing with different CAD software types

CAD/CAM Z-Tray software module – for the manufacture of custom impression trays

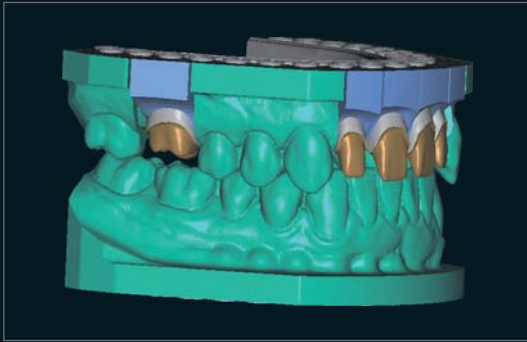

CAD/CAM MODEL MAKER SOFTWARE MODULE

- Customised setting of the parameters (distance between model and die, model thickness etc.)
- Automatic margin and undercut identification (ditching)
- Creation of positioning pins for transferring the digitally recorded occlusion into the laboratory articulator
- Creation of recesses for fixing the models in the occludator (mini articulator)
- Personalisation of the models with characters and logos
- Exportable data for manufacturing models with 3-D printers
- In combination with Zirkonzahn.Implant-Planner: service package for the dentist consisting of implant model, impression tray, surgical guide and temporary restoration

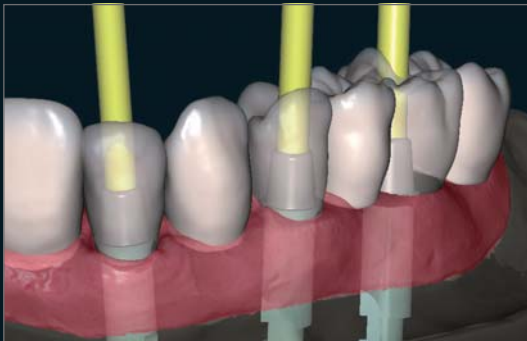

CAD/CAM OCCLUSALLY SCREWED BRIDGES SOFTWARE MODULE

- Module for the creation of occlusally screwed bridges and bars with individual profiles
- Free shaping of the emergence profile, taking into account the anatomic tooth shape and gingiva
- With the help of the scanbodies, the software calculates the alignment of the already included implants and uses it for the exact alignment of the screw channels
- Creation of threaded screw channels in the zirconia structure for sealing the restoration with sealing screws (Screw Blank) in the patient's mouth. The restoration can be easily removed by unscrewing the screws
- Attention – only works in combination with the CAD/CAM Occlusally Abutments software module

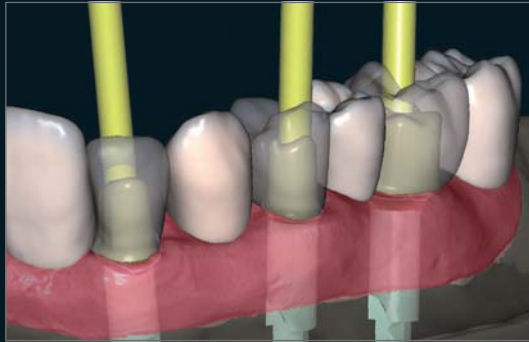

CAD/CAM ABUTMENTS SOFTWARE MODULE

- Module for the manufacture of individualised abutments and their emergence profile
- Creates abutments by taking into account the secondary construction
- Adjustable parameters: distance to secondary construction, shrinkage, etc.
- Semi-transparent display of the outer tooth form, which makes the creation of abutments much easier
- Supports a variety of implant systems stored that can be constructed either as directly screwed or as bonded titanium bases
- Implant positions that have been defined in the Zirkonzahn.Implant-Planner software can be imported via Scanmarkers and can be used for the production of the model and the provisional (for immediate loading)
- Attention – only works in combination with the CAD/CAM Occlusally Screwed Bridges software module

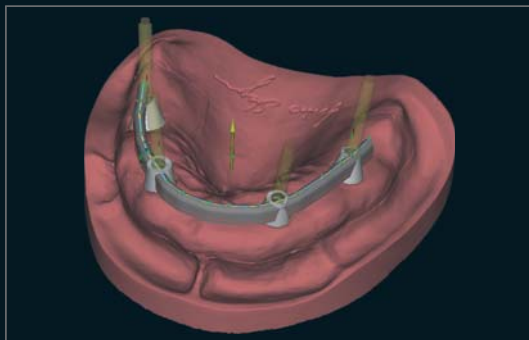

CAD/CAM BARS SOFTWARE MODULE

- Module for the individual manufacture of primary and hybrid bars (also implant-supported)
- Freely customisable emergence profile
- Semi-transparent display of the outer tooth form or separate situation scans, this greatly facilitates the manufacture of bars
- Different types of bars that can easily be modified
- Adjustable parameters: height, thickness, lingual and buccal angle, minimum size and thickness as well as many other individualisation options
- Fixing of attachments and retentions is possible as well as blanking out holes and anchorages

DIGITAL WORKFLOW FOR EDENTULOUS CASES

Our software supports all common implant systems and the bars design is done in relation to the secondary structure. With our software it is possible to produce any kind of restoration. From single crowns to 14-unit occlusally screw-retained bridges, everything can be manufactured with Zirkonzahn's CAD/CAM system in one's own laboratory. An example of workflow for the treatment of edentulous cases is shown below.

Case made by Dr. Francesco Mintrone, Sassuolo, Italy and MDT Antonio Corradini, Zirkonzahn Education Center Brunico, Italy



Creation of the patient case in the Zirkonzahn.Archiv software. All kind of data (intraoral scans, facial scans) can be imported and collected into the software.



Digital acquisition of the gingiva. The scan is transferred into the Zirkonzahn.Scan software and matched with all other patient data available. As an alternative to the intraoral scanner, conventional capturing methods with models and impressions can be used.

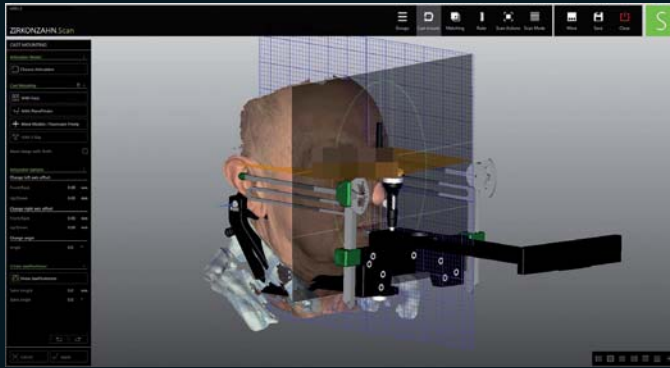

Digital acquisition of the patient's Natural Head Position and reference planes based on the PlaneSystem® concept (Udo Plaster, MDT). The patient's acquired data are transferred 1:1 into the Zirkonzahn.Scan software in the correct position and matched with 3D facial scans for the virtual articulation.

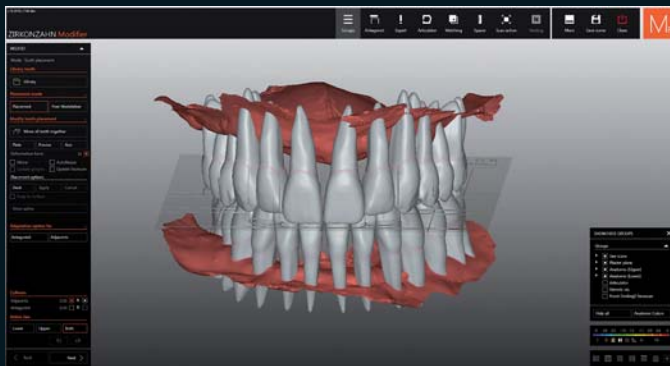

Based on the digitally recorded patient data, in the Zirkonzahn.Modifier software set-ups are designed for a first evaluation of aesthetics and function. The tooth anatomies are selected from the Heroes Collection virtual tooth library.

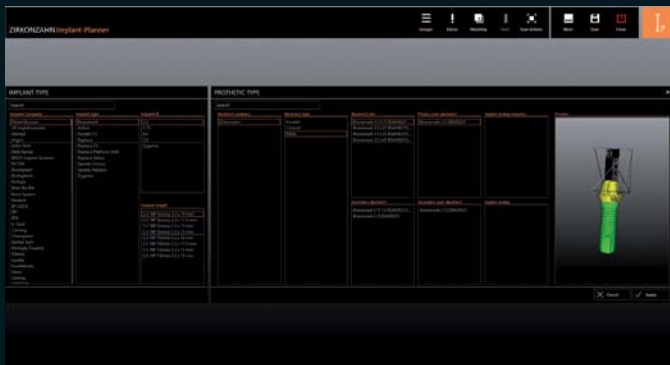

During the implant planning, the dentist can choose the implant systems, pins and drilling sleeves directly from the extensive libraries included in the software.



In the Zirkonzahn.Implant-Planner software, the implants positions are set by the dentist or proposed by the dental technician, taking bone density, function and aesthetics into account.



However, only after the dentist approval concerning the implants positions and inclinations can the dental technician design and mill (or print) the surgical guides.

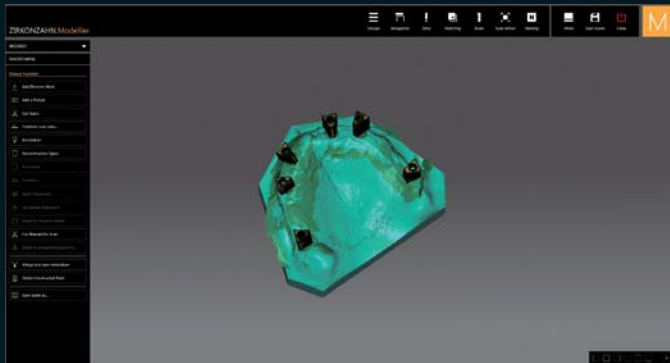

The correct implant positions are imported in the CAD software with virtual scanmarkers. The models are designed with ScanAnalog in the CAD/CAM Model Maker software module.



The physical models can be milled or printed and are provided with ScanAnalogos to reproduce the implant positions. They are used to check the fit of the surgical guides, the prototypes and the final restoration.

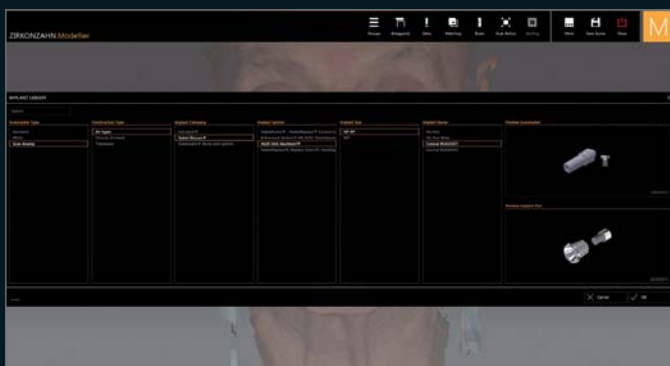

In the Zirkonzahn.Modellier software, the dental technician selects the same system and components used during the implant planning phase.

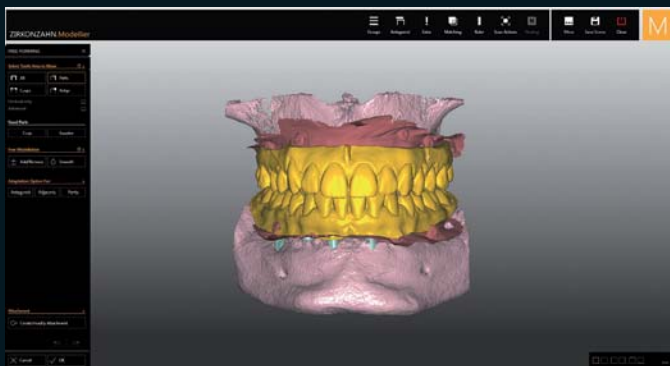

The resin prototypes for immediate loading are designed and milled.



The patient wears the prototypes until the implants have fully integrated into the bone.

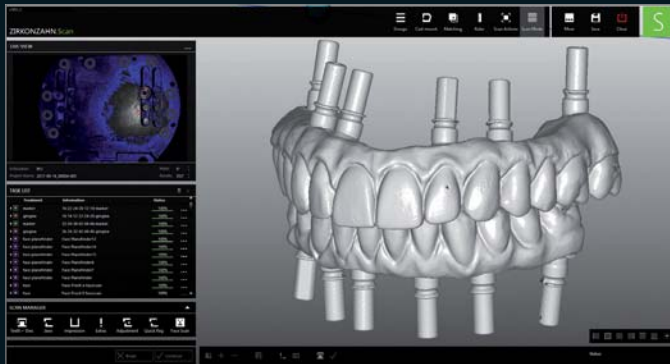

After the healing phase, the new situation is recorded by scanning the immediate prototypes with ScanAnalog. The impression of the gingiva is also taken and after matching these scan data, the provisionals of the final restorations are created. Alternatively, the intraoral scanner with White Scanmarkers can be used.

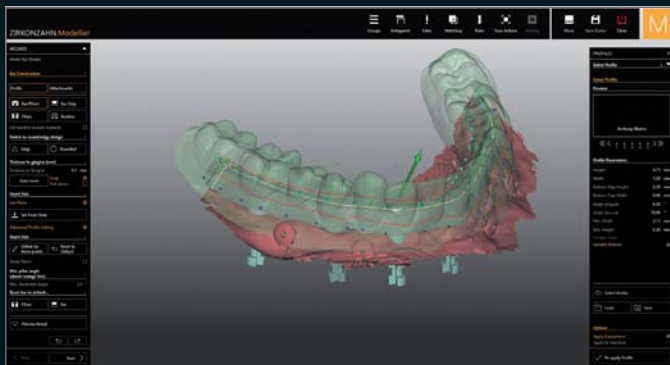

Once the provisionals are functionalised by the patient, they are scanned. Wax-ups are created to design the final zirconia restorations. The bar is designed, milled and then anodised with the Titanium Spectral-Colouring Anodizer or the Metal Colourizer.



The final restorations in Prettau® 2 zirconia, with anodised titanium bar and bases, are then manufactured. The maxillary restoration is provided with threaded screw channels.



To seal the Prettau® Bridges' screw channels, special resin screws are milled and applied directly in the patient's mouth.



The Prettau® Bridges in-situ.





Zirkonzahn®

IMPLANT PROSTHETICS

Zirkonzahn srl – Via An der Ahr 7 – 39030 Gais/South Tyrol

T +39 0474 066 680 – F +39 0474 066 661 – www.zirkonzahn.com – info@zirkonzahn.com



WEAA2321=